

LOTU

The fixing brand

2026

Gama

Range

Gamme

**Fabricación y distribución
de tornillería y fijaciones metálicas**

Desde hace más de 70 años proporcionando
soluciones al sector de la fijación

LOTU[®]

The fixing brand

2026

Gama

Range

Gamme

Lo que ofrecemos

what we offer

Ce que nous offrons



Innovación y experiencia de 74 años en fijación

Innovation and 74 years experience in fasteners

Innovation et de 74 ans dans les fixations experience



Orientación y servicio al cliente

Customer service and advice

Orientation et service au client



Soluciones para ensamblajes de piezas metálicas, aleaciones ligeras y materiales plásticos

Solutions for assembling metal parts, light alloys and plastic materials

Solutions pour l'assemblage de pièces métalliques, d'alliages légers et de matières plastiques



PR[®], DELTA PT[®], EVO PT[®], ALtracs[®], TORX[®], TORX Plus[®], MATHread[®], High Torque[®]

PR[®], DELTA PT[®], EVO PT[®], ALtracs[®], TORX[®], TORX Plus[®], MATHread[®], High Torque[®]

PR[®], DELTA PT[®], EVO PT[®], ALtracs[®], TORX[®], TORX Plus[®], MATHread[®], High Torque[®]



The fixing brand

Atención al Cliente

Customer service / Service au client

Tel.: +34 948 188 516

Fax: +34 948 188 470

Email: industrias@lotu.com

www.lotu.com



Compromiso con la calidad y el medioambiente

Commitment to quality and the environment

Engagement envers la qualité et l'environnement



Fabricación personalizada de elementos de fijación metálicos

Custom manufacturing of metal fasteners

Fabrication personnalisée éléments de fixations métalliques



Los medios tecnológicamente más avanzados

The most technologically advanced media

Les médias les plus avancés technologiquement



Especialistas en los sectores industriales de Automoción, Electrodomésticos y Energías renovables

Specialists in the automotive, household appliances, and renewable energy industrial sectors

Spécialistes des secteurs industriels de l'automobile, de l'électroménager et des énergies renouvelables



Amplio catálogo de piezas estándar para el sector DISTRIBUCIÓN con más de 5.000 referencias en stock

Extensive catalog of standard parts for the DISTRIBUTION sector with more than 5,000 references in stock

Vaste catalogue de pièces standards pour le secteur de la DISTRIBUTION avec plus de 5 000 références en stock

Comprometidos con la calidad desde 1951

Committed to quality since 1951
Engagés pour la qualité depuis 1951



Desde 1951, LOTU, S.A. fabrica soluciones de tornillería técnica con precisión, fiabilidad y un firme compromiso con la calidad. Nuestra experiencia y capacidad de adaptación nos han convertido en un proveedor de referencia en sectores como la automoción, la maquinaria industrial y la construcción.



Contamos con certificaciones internacionales que avalan nuestros sistemas de gestión de calidad y medio ambiente, como UNE-ISO/TS 16949, ISO 9001:2008 e ISO 14001:2004, emitidas por organismos reconocidos como AENOR e IQNet. Estos sellos reflejan nuestra apuesta por la mejora continua, la eficiencia de procesos y el respeto por el entorno.



Since 1951, LOTU, S.A. has been manufacturing high-precision fasteners with reliability and a strong commitment to quality. Our experience and adaptability have made us a trusted supplier in sectors such as automotive, industrial machinery, and construction.

Depuis 1951, LOTU, S.A. fabrique des solutions de fixation techniques avec précision, fiabilité et un engagement fort envers la qualité. Notre expérience et notre capacité d'adaptation font de nous un fournisseur de confiance dans des secteurs comme l'automobile, la machinerie industrielle et le bâtiment.



We hold international certifications that endorse our quality and environmental management systems, including UNE-ISO/TS 16949, ISO 9001:2008, and ISO 14001:2004, awarded by recognized bodies such as AENOR and IQNet. These accreditations reflect our dedication to continuous improvement, process efficiency, and environmental responsibility.

Nous possédons des certifications internationales qui valident nos systèmes de gestion de la qualité et de l'environnement, telles que UNE-ISO/TS 16949, ISO 9001:2008 et ISO 14001:2004, délivrées par des organismes reconnus comme AENOR et IQNet. Ces distinctions témoignent de notre engagement envers l'amélioration continue, l'efficacité des processus et le respect de l'environnement.



UNE-ISO/TS 16949



ER-0202/1996



GA-2004/0203



ISO 14001:2004



ISO 9001:2008

I+D+i

Piezas especiales

Engineered fasteners
Vis especiales

Toda la experiencia acumulada durante estos años, contribuye a que nuestro Dpto. Técnico e Ingeniería de Producto se anticipe a la constante evolución del mercado.

La innovación y el desarrollo ha sido uno de los motores de Industrias Lotu desde su creación. Gracias a la investigación continuada somos capaces de desarrollar soluciones particulares y adaptadas a cualquier cliente.

Nuestro compromiso con la investigación de nuevos productos y materiales, se realiza con la colaboración y apoyo de importantes centros tecnológicos y universitarios.

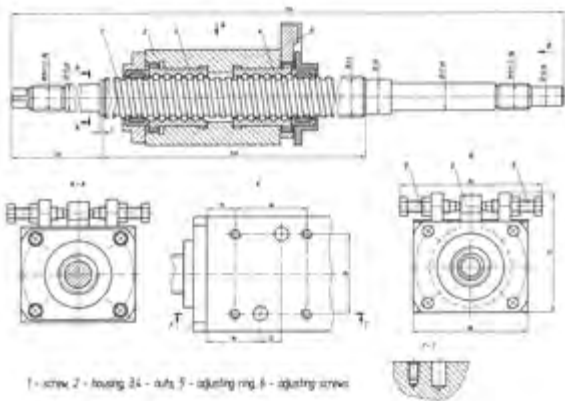

The experience gained over all this time means that our Technical and Product Engineering Department can anticipate the constant changes taking place in the market.

Innovation and development have been the driving force behind Industrias Lotu since day one. Thanks to continuous research, we are able to develop specific solutions adapted to each and every customer.

Our commitment to research into new products and materials is carried through with support from and in collaboration with important technology centres and universities.

Grâce l'expérience accumulée au fil des ans, notre Département Technique anticipe en permanence les évolutions du marché.

L'innovation et le développement ont été l'un des moteurs de Industrias Lotu depuis sa création. La recherche constante nous permet de mettre au point des solutions particulières et adaptées à chaque client.

Notre engagement dans la recherche de nouveaux produits et matériaux, se fait en collaboration et avec l'aide d'importants centres technologiques et universitaires.







Índice Contents Sommaire

Rosca madera

Chipboard Screw
Vis a bois aglomerée filet 40°

14

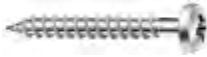



	COD.	PAG.		COD.	PAG.
	FREM	16		7505-A (TX)	22
	TAPÓN ADHESIVO	17		TP-TX	23
	FREM TXXL	19		7505-B (PZ)	24
	7505-A (PZ)	20			

Rosca doble hilo

Double thread wood screw
Vis a bois a deux filets

26

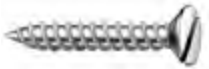

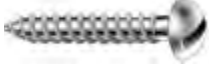
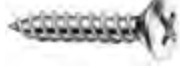
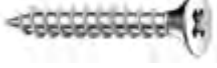
	COD.	PAG.		COD.	PAG.
	RAN-72	28		PHI-81	30
	RAN-74	29		GSB-83	31
	PHI-82	30			











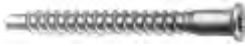

Carpintería madera

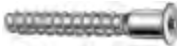
Special wood screws - various
Vis special pour bois - divers

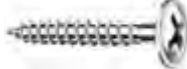
32

7

COD.	PAG.	COD.	PAG.
 CM-ENS 5	34	 TIR-PZ	37
 TP-ENS 5	34	 TIR-RAN	37
 CM-ENP 5	34	 TIR MULTI	38
 CM-ENS 7	35	 SILLA	38
 TP-ENS 7	35	 CM-ARPZ	39
 CM-TX	36	 TORNILLO INVIOLEABLE	39
 CM-GSB	36	 DIN 571	40

Rosca métrica

Machine Screw
Vis a métaux

42



	COD.	PAG.		COD.	PAG.
	DIN 84-4.8	44		TUERCA DIN 6923	53
	DIN 963-4.8	45		TUERCA DIN 315 MARIPOSA	53
	DIN 965-4.8	46		ARANDELA DIN 125 A	53
	DIN 7985-4.8	47		ARANDELA DIN 9021	54
	DIN 933-8.8	48		ARANDELA DIN 9021 INOX.	54
	DIN 931-8.8	50		ARANDELA DIN 127 B	54
	DIN 912-8.8	51		DIN 7500 C	55
	VARILLA ROSCADA	51		DIN 7500 C TX	56
	TUERCA DIN 934	52		DIN 7500 M	57
	TUERCA DIN 934 INOX.	52		DIN 7500 MTX	57
	TUERCA DIN 985 AUTOBLOCANTE	52			

Rosca chapa

Self tapping screw
Vis a tôle

60









	COD.	PAG.		COD.	PAG.
	DIN 7981	62		DIN 7982 TX	67
	DIN 7981 F	64		DIN 7982	68
	DIN 7981 G	65		DIN 7983	70
	11C-91	65		DIN 7971	72
	DIN 7981 TX	66			



Autotaladrante

Self drilling screw
Vis a tôle autoperceuse

74









COD.	PAG.	COD.	PAG.
 DIN 7504-N	76	 DIN 7504-K	79
 DIN 7504-NTX	77	 DIN 7301	80
 16B-91	77	 ARANDELA DE CLOROPRENO	81
 DIN 7504-P	78		

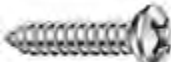

Carpintería aluminio

Screws for aluminium frames
Vis pour charpentes

82





COD.	PAG.	COD.	PAG.
 AL-81	84	 ALX PLA	86
 TP-ENV	84	 ALX PLA BRO	86
 AL-CE	85	 AL-JR	87
 AL-CE BRO	85	 AL-JP	87
 DIN 7991-8.8	85		

Carpintería PVC

PVC application screw
Vis pour application au PVC

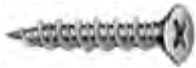
88



	COD.	PAG.		COD.	PAG.
	CPV10	90		CPV-FM	91
	CPV20	90		CPV-35	91
	CPV50	91			

Cubiertas y fachadas

Roofing and cladding screws
Vis pour des façades et des couvertures

92







	COD.	PAG.		COD.	PAG.
	DIN 6928-ARAN	94		CF-NYLON	99
	DIN 6928	94		CF-BNYLON	99
	DIN 7504-K	95		CF-RNYLON	99
	DIN 7301	96		CF-CAP	100
	TORNILLO VIGA	96		CF-HOR	100
	ARANDELA ACERO/INOX CON CLOROPRENO	97		CF-HORA	101
	CF-RED	97		CF-SAND	102
	CF-ARA RED	97		CF-SANDAL	102
	CF-AIS RED	98		CF-FIBRO	103
	CF-AIS PHI	98		CF-ALA	103
	CF-NER	98			



Electricista

Screws and accessories for electricians
Vis et accessoires pour électriciens

104









COD.	PAG.	COD.	PAG.
 ELEC-71	106	 BRIDAS NYLON	107
 ELEC-81	106	 TACO BRIDA NEGRO	107



Cartón-Yeso

Drywall screws and accessories
Vis et accessoires pour plaques de plâtre

108



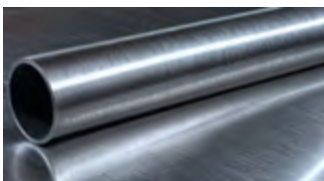





COD.	PAG.	COD.	PAG.
 PLA-F	110	 TACO ZAMAK AUTOPERFORANTE SPZ	111
 PLA-P	110	 TACO DE NYLON HAV	111
 PLA-B	110	 TACO CLAVABLE CABEZA CILÍNDRICA	111
 TORNILLO ENCINTADO FE	110	 TACO FIJACIÓN AISLANTE	111
 TACO DE NYLON SP AUTOPERFORANTE	111		



Acero Inoxidable

Stainless steel
Acier inoxydable

112

COD.	PAG.	COD.	PAG.
 7505-A (PZ)	114	 ARANDELA DE CLOROPRENO INOXIDABLE	119
 DIN 7981 INOXIDABLE	115	 TUERCA DIN 934 INOXIDABLE	119
 DIN 571 INOXIDABLE	117	 TUERCA DIN 6923 INOXIDABLE	119
 DIN 933 INOXIDABLE	118	 VARILLA ROSCADA INOXIDABLE	119
 ARANDELA DIN 9021 INOXIDABLE	118		

Fijaciones

Fastening products
Produits de fixation

120











COD.	PAG.	COD.	PAG.
 ANCLAJE DROP HEMBRA	122	 TACO NYLON N	125
 ANCLAJE LATÓN NTO	122	 TACO NYLON TOP CON Y SIN COLLARÍN	125
 ANCLAJE METÁLICO CARGAS ALTAS	123	 TACO NYLON A	125
 ANCLAJE CARGAS MEDIAS TORNILLO	124	 TACO NYLON AB CON COLLARÍN	126
 ANCLAJE CARGAS MEDIAS ARGOLLA	124	 ANCLAJE METÁLICO INOX	127
 ANCLAJE CARGAS MEDIAS GANCHO	124	 ARANDELAS INOX	127

Tapones

Caps
Bouchons

128



COD.	PAG.	COD.	PAG.
 TP-FONDO	130	 TP-ENSHI-LO	132
 TP-ENV	130	 TP-TORX	132
 TAPÓN-CAP-BOUCHON	131	 TAPÓN ADHESIVO PARA TORNILLO CABEZA PLANA	133
 TP-CIL	131	 CF-CAP	133
 TP-ENS	132		



Puntas

Bits
Embouts

134

COD.	PAG.	COD.	PAG.
 PUNTAS PLANAS 1/4"X25	136	 PUNTAS ALLEN 1/4"X25	138
 PUNTAS PHILIPS 1/4"X25	136	 APRIETA TUERCAS 1/4" MAGNÉTICOS	138
 PUNTAS PHILIPS 1/4"X50	136	 ADAPTADOR MAGNÉTICO 1/4 PARA PUNTAS 1/4"	138
 PUNTAS PHILIPS 1/4"X25 EXTRA DURAS	136	 ADAPTADOR MAGNÉTICO + ANILLO DE RETENCIÓN DE 1/4 PARA PUNTAS 1/4"	138
 PUNTAS PHILIPS 1/4"X50a EXTRA DURAS	136	 ADAPTADOR MAGNÉTICO DE CAMBIO RÁPIDO DE 1/4 PARA PUNTAS 1/4"	138
 PUNTAS POZIDRIV 1/4"X25 EXTRA DURAS	137	 DESTORNILLADOR PORTA PUNTAS DE 1/4" CON DEPÓSITO	139
 PUNTAS POZIDRIV 1/4"X50 EXTRA DURAS	137	 RAPIDAPTOR® UNIVERSAL C+E 1/4"	139
 PUNTAS TORX 1/4"X25 EXTRA DURAS	137	 DESTORNILLADOR PORTA PUNTAS KRAFTFORM KOMPAKT® 20 CON BOLSA	139
 PUNTAS TORX 1/4"X25 EXTRA DURAS	137		



Otros elementos de fijación

Other fastenings
Autres éléments de fixation

140

COD.	PAG.	COD.	PAG.
 ALCAYATAS ACERO CINCADO	142	 PUNTAS CABEZA PERDIDA ACERO PULIDO	143
 ESCARPIAS ACERO CINCADO	142	 PUNTAS CABEZA PLANA ACERO PULIDO	144
 HEMBRILLAS ABIERTAS ACERO CINCADO	142	 PUNTAS CABEZA REDONDA ACERO TEMPLADO	145
 HEMBRILLAS CERRADAS ACERO CINCADO	143	 GRAMPILLONES ACERO PULIDO	145
 PUNTAS CABEZA PERDIDA LATONADO	143	 TACHUELA TAPICERO CINCADEA	145
 PUNTAS CABEZA PERDIDA COBREADO	143	 PUNTA CABEZA ANCHA	145

LOTU[®]

The fixing brand



Rosca madera

Chipboard Screw

Vis a bois aglomerée fileté 40°



Especificaciones en pág. 146



855/1 TH Extra Dura
Cruz pozidriv
Punta atornillador
1/4" x 25



855/4 TH Extra Dura
Cruz pozidriv
Punta atornillador
1/4" x 50

Ø Tornillo (mm)	+
2,50 - 3,00	PZ-1
3,50 - 4,50	PZ-2
5,00	PZ-3

Especificaciones en pág. 134

FREM

Cabeza plana pozi rosca cortante un hilo 40° punta fresada

Pozi countersunk head chipboard thread cutting screw
Vis a bois aglomerée filet 40° special tête fraisée pozi



Medida Size Dimension	Bicromatado Yellow Zinc Plated Bichromaté	Cincado Zinc plated Zingué	Cincado Negro Black Zinc plated Zingué Noir	Envasado Packing Emboitage	Embalaje Carton Emballage
mm.	€/1.000	€/1.000	€/1.000	Und.	nd.
2,5 x 16	*	*	*	1.000	18.000
2,5 x 20	*	*	*	1.000	9.000
2,5 x 25	*	*	*	1.000	9.000
2,5 x 30	*	*	*	1.000	9.000
3,0 x 12	*	*	*	1.000	18.000
3,0 x 16	*	*	*	1.000	9.000
3,0 x 20	*	*	*	1.000	9.000
3,0 x 25	*	*	*	500	4.500
3,0 x 30	*	*	*	500	4.500
3,0 x 35	*	*	*	500	4.500
3,0 x 40	*	*	*	500	3.000
3,5 x 12	*	*	*	1.000	9.000
3,5 x 16	*	*	*	1.000	9.000
3,5 x 20	*	*	*	1.000	9.000
3,5 x 25	*	*	*	500	4.500
3,5 x 30	*	*	*	500	4.500
3,5 x 35	*	*	*	500	4.500
3,5 x 40	*	*	*	500	3.000
3,5 x 45	*	*	*	500	3.000
3,5 x 50	*	*	*	200	1.800
4,0 x 16	*	*	*	500	9.000
4,0 x 20	*	*	*	500	4.500
4,0 x 25	*	*	*	500	4.500
4,0 x 30	*	*	*	500	4.500
4,0 x 35	*	*	*	500	3.000
4,0 x 40	*	*	*	500	3.000
4,0 x 45	*	*	*	200	1.800
4,0 x 50	*	*	*	200	1.800
4,0 x 60	*	*	*	200	1.200
4,0 x 70	*	*	*	200	1.200
4,5 x 20	*	*	*	500	4.500
4,5 x 25	*	*	*	500	3.000
4,5 x 30	*	*	*	500	3.000
4,5 x 35	*	*	*	500	3.000
4,5 x 40	*	*	*	200	1.800
4,5 x 45	*	*	*	200	1.800
4,5 x 50	*	*	*	200	1.200
4,5 x 60	*	*	*	200	1.200
4,5 x 70	*	*	*	100	900
4,5 x 80	*	*	*	100	900

FREM

Cabeza plana pozi rosca cortante un hilo 40° punta fresada

Pozi countersunk head chipboard thread cutting screw

Vis a bois aglomerée filet 40° special tête fraisée pozi



EXENTO
DE
CROMO
VI

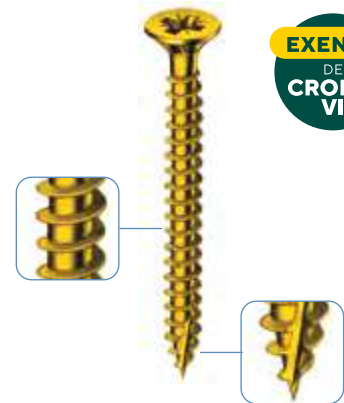

Especificaciones en pág. 146

Medida Size Dimension	Bicromatado Yellow Zinc Plated Bichromaté	Cincado Zinc plated Zingué	Cincado Negro Black Zinc plated Zingué Noir	Envasado Packing Emboîtage	Embalaje Carton Emballage
mm.	€/1.000	€/1.000	€/1.000	Und.	Und.
5,0 x 30	*	*	*	200	1.800
5,0 x 35	*	*	*	200	1.800
5,0 x 40	*	*	*	200	1.800
5,0 x 45	*	*	*	200	1.200
5,0 x 50	*	*	*	200	1.200
5,0 x 60	*	*	*	100	900
5,0 x 70	*	*	*	100	900
5,0 x 80	*	*	*	100	900
5,0 x 90	*	*	*	100	900
5,0 x 100	*	*	*	100	600
6,0 x 60	*	*	*	100	600
6,0 x 70	*	*	*	100	600
6,0 x 80	*	*	*	100	600
6,0 x 100	*	*	*	100	600
6,0 x 120	*	*	*	100	600

Tapón adhesivo para tornillo cabeza plana

Adhesive cap for countersunk head chipboard screw

Bouchon adhesif pour vis a bois aglomerée tête fraisée

Precio Price Prix	Envasado Packing Emboîtage	Embalaje Carton Emballage
€/1.000	Und.	Und.
*	1.000	9.000



Tapón adhesivo
Adhesiva Cap
Bouchon adhesif

Colores disponibles

Colours / Couleurs





FREM TX XL

Estrías bajo cabeza - Rosca Helicoidal Cortante - Punta Fresada

Nibs under head - Intermediate helix & cutting thread - point type 17

Tête cratée - spécial filet - pointe fraisée

CE
EN 14592

Medida Size Dimension	Bicromatado Yellow Zinc Plated Bichromaté	Envasado Packing Emboîtage	Embalaje Carton Emballage
mm.	€/1.000	Und.	Und.
8 x 180	*	50	200
8 x 200	*	50	200
8 x 220	*	50	200
8 x 240	*	50	200
8 x 260	*	50	200
8 x 280	*	50	200
8 x 300	*	50	200

Entalla TX
Asegurando un par de
atornillado alto.
Hexalobular recess

Mínimo esfuerzo, máximo rendimiento

Minimum torque, maximum performance

Estrías bajo la cabeza

Facilita el avellanado de la madera.

Nibs under head

Rosca cortante

En los primeros hilos de la rosca.

Cutting threads

Rosca helicoidal

Reduce la resistencia a la fricción en el ensamblado. Realiza la labor de autolimpieza de la viruta generada.

Intermediate transition helix

Punta fresada

Ayuda a la entrada del tornillo. Evita que la madera se agriete.

Sharp point 17

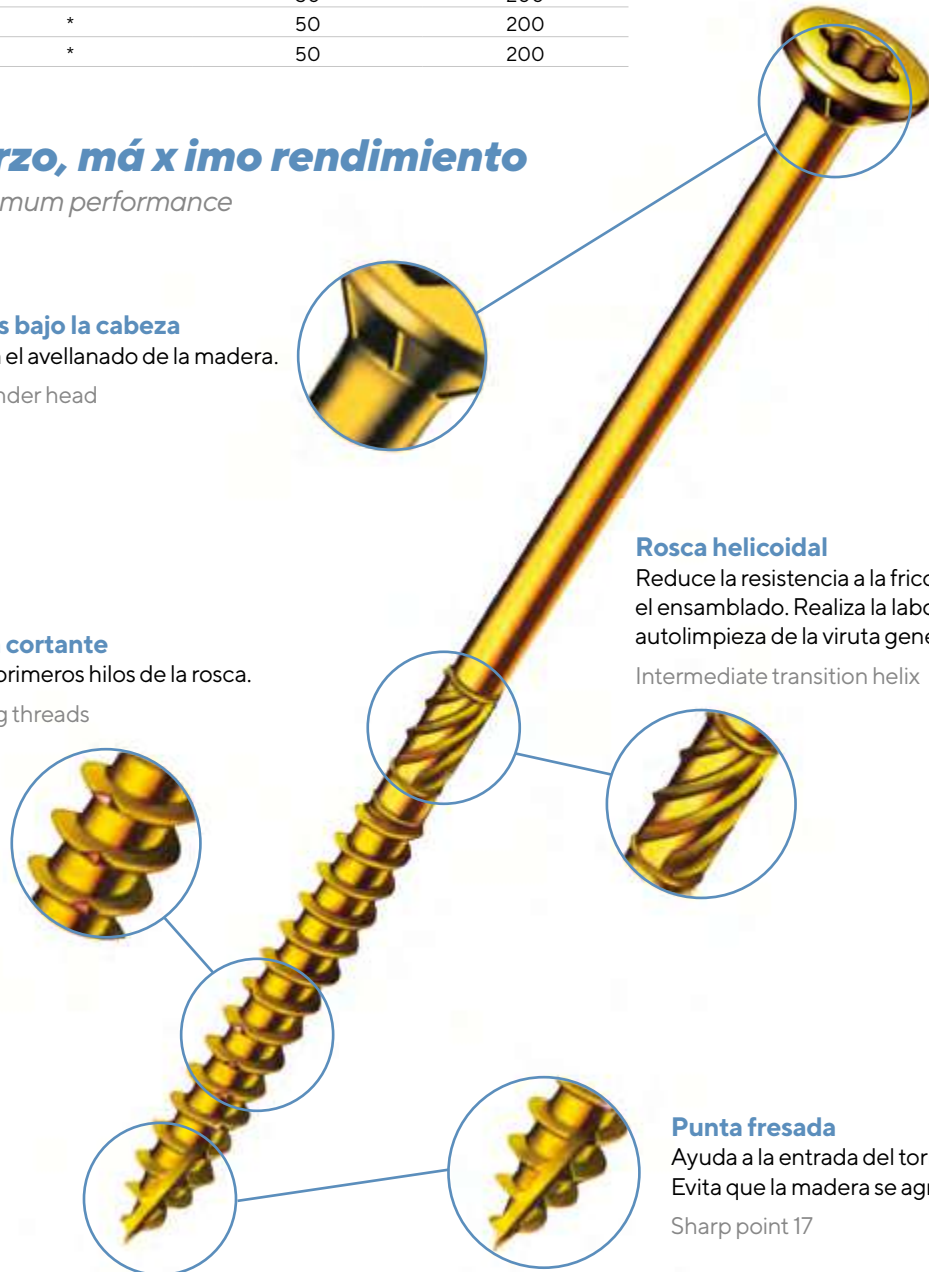



Especificaciones en pág. 146



Tapón adhesivo
Adhesiva Cap
Bouchon adhesif



855/1 TH Extra Dura
Cruz pozidriv
Punta atornillador
1/4" x 25



855/4 TH Extra Dura
Cruz pozidriv
Punta atornillador
1/4" x 50

Ø Tornillo (mm)

2,50 - 3,00	PZ-1
3,50 - 4,50	PZ-2
5,00	PZ-3

Especificaciones en pág. 134

7505-A (PZ)

Cabeza plana pozi rosca un hilo 40°

Pozi countersunk head chipboard screw

Vis a bois aglomerée filet tête fraisée pozi



EN 14592

Medida Size Dimension	Bicromatado Yellow Zinc Plated Bichromaté	Cincado Zinc plated Zingué	Cincado Negro Black Zinc plated Zingué Noir	Inoxidable Stainless Steel A2	Envasado Packing Emboitage	Embalaje Carton Emballage
mm.	€/1.000	€/1.000	€/1.000	€/1.000	Und.	Und.
2,5 x 10	*	*	*	*	1.000	18.000
2,5 x 12	*	*	*	*	1.000	18.000
2,5 x 13	*	*	*	*	1.000	18.000
2,5 x 15	*	*	*	*	1.000	18.000
2,5 x 16	*	*	*	*	1.000	18.000
2,5 x 17	*	*	*	*	1.000	18.000
2,5 x 20	*	*	*	*	1.000	9.000
2,5 x 25	*	*	*	*	1.000	9.000
2,5 x 30	*	*	*	*	1.000	9.000
3,0 x 10	*	*	*	*	1.000	18.000
3,0 x 12	*	*	*	*	1.000	18.000
3,0 x 13	*	*	*	*	1.000	18.000
3,0 x 15	*	*	*	*	1.000	9.000
3,0 x 16	*	*	*	*	1.000	9.000
3,0 x 17	*	*	*	*	1.000	9.000
3,0 x 20	*	*	*	*	1.000	9.000
3,0 x 25	*	*	*	*	500	4.500
3,0 x 30	*	*	*	*	500	4.500
3,0 x 35	*	*	*	*	500	4.500
3,0 x 40	*	*	*	*	500	3.000
3,5 x 10	*	*	*	*	1.000	9.000
3,5 x 12	*	*	*	*	1.000	9.000
3,5 x 13	*	*	*	*	1.000	9.000
3,5 x 15	*	*	*	*	1.000	9.000
3,5 x 16	*	*	*	*	1.000	9.000
3,5 x 17	*	*	*	*	1.000	9.000
3,5 x 20	*	*	*	*	1.000	9.000
3,5 x 25	*	*	*	*	500	4.500
3,5 x 30	*	*	*	*	500	4.500
3,5 x 35	*	*	*	*	500	4.500
3,5 x 40	*	*	*	*	500	3.000
3,5 x 45	*	*	*	*	500	3.000
3,5 x 50	*	*	*	*	200	1.800
4,0 x 12	*	*	*	*	500	9.000
4,0 x 13	*	*	*	*	500	9.000
4,0 x 15	*	*	*	*	500	9.000
4,0 x 16	*	*	*	*	500	9.000
4,0 x 17	*	*	*	*	500	9.000
4,0 x 20	*	*	*	*	500	4.500
4,0 x 25	*	*	*	*	500	4.500
4,0 x 30	*	*	*	*	500	4.500
4,0 x 35	*	*	*	*	500	3.000
4,0 x 40	*	*	*	*	500	3.000
4,0 x 45	*	*	*	*	200	1.800
4,0 x 50	*	*	*	*	200	1.800
4,0 x 60	*	*	*	*	200	1.200
4,0 x 70	*	*	*	*	200	1.200

7505-A (PZ)

Cabeza plana pozi rosca un hilo 40°

Pozi countersunk head chipboard screw

Vis a bois aglomerée filet tête fraisée pozi

Medida Size Dimension	Bicromatado Yellow Zinc Plated Bichromaté	Cincado Zinc plated Zingué	Cincado Negro Black Zinc plated Zingué Noir	Inoxidable Stainless Steel A2	Envasado Packing Emboitage	Embalaje Carton Emballage
mm.	€/1.000	€/1.000	€/1.000	€/1.000	Und.	Und.
4,5 x 15	*	*	*	*	500	4.500
4,5 x 16	*	*	*	*	500	4.500
4,5 x 17	*	*	*	*	500	4.500
4,5 x 20	*	*	*	*	500	4.500
4,5 x 25	*	*	*	*	500	3.000
4,5 x 30	*	*	*	*	500	3.000
4,5 x 35	*	*	*	*	500	3.000
4,5 x 40	*	*	*	*	200	1.800
4,5 x 45	*	*	*	*	200	1.800
4,5 x 50	*	*	*	*	200	1.200
4,5 x 60	*	*	*	*	200	1.200
4,5 x 70	*	*	*	*	100	900
4,5 x 80	*	*	*	*	100	900
5,0 x 20	*	*	*	*	500	4.500
5,0 x 25	*	*	*	*	500	3.000
5,0 x 30	*	*	*	*	200	1.800
5,0 x 35	*	*	*	*	200	1.800
5,0 x 40	*	*	*	*	200	1.800
5,0 x 45	*	*	*	*	200	1.200
5,0 x 50	*	*	*	*	200	1.200
5,0 x 60	*	*	*	*	100	600
5,0 x 70	*	*	*	*	100	900
5,0 x 80	*	*	*	*	100	600
5,0 x 90	*	*	*	*	100	600
5,0 x 100	*	*	*	*	100	600
6,0 x 50	*	*	*	*	200	1.200
6,0 x 60	*	*	*	*	100	600
6,0 x 70	*	*	*	*	100	600
6,0 x 80	*	*	*	*	100	600
6,0 x 90	*	*	*	*	100	600
6,0 x 100	*	*	*	*	100	600
6,0 x 120	*	*	*	*	100	600
6,0 x 140	*	*	*	*	100	600

***Consultar precios para tornillería inoxidable**

*Inquire for stainless steel prices

*Demande de prix pour A2 Intermediate transition helix



Especificaciones en pág. 146

**Tapón adhesivo**Adhesiva Cap
Bouchon adhesif**855/1 TH Extra Dura**Cruz pozidriv
Punta atornillador
1/4" x 25**855/4 TH Extra Dura**Cruz pozidriv
Punta atornillador
1/4" x 50**Ø Tornillo (mm)**

2,50 - 3,00	PZ-1
3,50 - 4,50	PZ-2
5,00	PZ-3

Especificaciones en pág. 134



Especificaciones en pág. 146



867/1TZ 
Entalla TX
Punta atornillador
1/4" x 25



867/4TZ 
Entalla TX
Punta atornillador
1/4" x 50

Ø Tornillo (mm) 

3,50 - 4,00	TX -20
4,50 - 5,00	TX -25
6,00	TX -30

Especificaciones en pág. 134

7505-A (TX)

Cabeza plana TX rosca un hilo 40°

TX countersunk head chipboard screw

Vis a bois aglomerée filet 40° tête fraisée TX



EN 14592

Medida Size Dimension	Bicromatado Yellow Zinc Plated Bichromaté	Cincado Zinc plated Zingué	Envasado Packing Emboîtage	Embalaje Carton Emballage
mm.	€/1.000	€/1.000	Und.	Und.
3,5 x 16	*	*	1.000	9.000
3,5 x 20	*	*	1.000	9.000
3,5 x 25	*	*	500	4.500
3,5 x 30	*	*	500	4.500
3,5 x 35	*	*	500	4.500
3,5 x 40	*	*	500	3.000
3,5 x 45	*	*	500	3.000
3,5 x 50	*	*	200	1.800
4,0 x 25	*	*	500	4.500
4,0 x 30	*	*	500	4.500
4,0 x 35	*	*	500	3.000
4,0 x 40	*	*	500	3.000
4,0 x 45	*	*	200	1.800
4,0 x 50	*	*	200	1.800
4,0 x 60	*	*	200	1.200
4,5 x 30	*	*	500	3.000
4,5 x 35	*	*	500	3.000
4,5 x 40	*	*	200	1.800
4,5 x 45	*	*	200	1.800
4,5 x 50	*	*	200	1.200
4,5 x 60	*	*	200	1.200
4,5 x 70	*	*	100	900
5,0 x 35	*	*	200	1.800
5,0 x 40	*	*	200	1.800
5,0 x 45	*	*	200	1.200
5,0 x 50	*	*	200	1.200
5,0 x 60	*	*	100	600
5,0 x 70	*	*	100	900
5,0 x 80	*	*	100	600
5,0 x 90	*	*	100	600
5,0 x 100	*	*	100	600
6,0 x 60	*	*	100	600
6,0 x 80	*	*	100	600
6,0 x 90	*	*	100	600
6,0 x 100	*	*	100	600
6,0 x 120	*	*	100	600
6,0 x 140	*	*	100	600
6,0 x 160	*	*	100	600

TP - TX

Tapón plástico para tornillo cabeza plana TX

Plastic cap for TX countersunk head chipboard screw

Bouchon a plastique pour vis a bois aglomerée filet 40° tête fraisée TX



	Precio Price Prix	Envasado Packing Emboîtage	Embalaje Carton Emballage
	€/1.000	Und.	Und.
Tor x -20	*	1.000	9.000
Tor x -25	*	1.000	9.000

Colores disponibles

Colours / Couleurs





Especificaciones en pág. 146



855/1TH Extra Dura

Cruz pozidriv
Punta atornillador
1/4" x 25



855/4TH Extra Dura

Cruz pozidriv
Punta atornillador
1/4" x 50

Ø Tornillo (mm)

2,50 - 3,00	PZ-1
3,50 - 4,50	PZ-2
5,00	PZ-3

Especificaciones en pág. 134

7505-B (PZ)

Cabeza alomada pozi rosca un hilo 40°

Pozi pan head chipboard screw

Vis a bois aglomerée 40° tête cylindrique bombée large pozi

Medida Size Dimension	Bicromatado Yellow Zinc Plated Bichromaté	Cincado Zinc plated Zingué	Cincado Negro Black Zinc plated Zingué Noir	Envasado Packing Emboitage	Embalaje Carton Emballage
mm.	€/1.000	€/1.000	€/1.000	Und.	Und.
2,5 x 10	*	*	*	1.000	18.000
2,5 x 12	*	*	*	1.000	18.000
2,5 x 13	*	*	*	1.000	18.000
2,5 x 15	*	*	*	1.000	18.000
2,5 x 16	*	*	*	1.000	18.000
2,5 x 17	*	*	*	1.000	18.000
2,5 x 20	*	*	*	1.000	9.000
2,5 x 25	*	*	*	1.000	9.000
2,5 x 30	*	*	*	1.000	9.000
3,0 x 10	*	*	*	1.000	18.000
3,0 x 12	*	*	*	1.000	18.000
3,0 x 13	*	*	*	1.000	18.000
3,0 x 15	*	*	*	1.000	9.000
3,0 x 16	*	*	*	1.000	9.000
3,0 x 17	*	*	*	1.000	9.000
3,0 x 20	*	*	*	1.000	9.000
3,0 x 25	*	*	*	500	4.500
3,0 x 30	*	*	*	500	4.500
3,0 x 35	*	*	*	500	4.500
3,0 x 40	*	*	*	500	3.000
3,5 x 10	*	*	*	1.000	9.000
3,5 x 12	*	*	*	1.000	9.000
3,5 x 13	*	*	*	1.000	9.000
3,5 x 15	*	*	*	1.000	9.000
3,5 x 16	*	*	*	1.000	9.000
3,5 x 17	*	*	*	1.000	9.000
3,5 x 20	*	*	*	1.000	9.000
3,5 x 25	*	*	*	500	4.500
3,5 x 30	*	*	*	500	4.500
3,5 x 35	*	*	*	500	4.500
3,5 x 40	*	*	*	500	3.000
3,5 x 45	*	*	*	500	3.000
3,5 x 50	*	*	*	200	1.800
4,0 x 12	*	*	*	500	9.000
4,0 x 13	*	*	*	500	9.000
4,0 x 15	*	*	*	500	9.000
4,0 x 16	*	*	*	500	9.000
4,0 x 17	*	*	*	500	9.000
4,0 x 20	*	*	*	500	4.500
4,0 x 25	*	*	*	500	4.500
4,0 x 30	*	*	*	500	4.500
4,0 x 35	*	*	*	500	3.000
4,0 x 40	*	*	*	500	3.000
4,0 x 45	*	*	*	200	1.800
4,0 x 50	*	*	*	200	1.800
4,0 x 60	*	*	*	200	1.200
4,0 x 70	*	*	*	200	1.200

7505-B (PZ)

Cabeza alomada pozi rosca un hilo 40°

Pozi pan head chipboard screw

Vis a bois aglomerée 40° tête cylindrique bombée large pozi

Medida Size Dimension	Bicromatado Yellow Zinc Plated Bichromaté	Cincado Zinc plated Zingué	Cincado Negro Black Zinc plated Zingué Noir	Envasado Packing Emboitage	Embalaje Carton Emballage
mm.	€/1.000	€/1.000	€/1.000	Und.	Und.
4,5 x 15	*	*	*	500	4.500
4,5 x 16	*	*	*	500	4.500
4,5 x 17	*	*	*	500	4.500
4,5 x 20	*	*	*	500	4.500
4,5 x 25	*	*	*	500	3.000
4,5 x 30	*	*	*	500	3.000
4,5 x 35	*	*	*	500	3.000
4,5 x 40	*	*	*	200	1.800
4,5 x 45	*	*	*	200	1.800
4,5 x 50	*	*	*	200	1.200
4,5 x 60	*	*	*	200	1.200
4,5 x 70	*	*	*	100	900
5,0 x 20	*	*	*	500	4.500
5,0 x 25	*	*	*	500	3.000
5,0 x 30	*	*	*	200	1.800
5,0 x 35	*	*	*	200	1.800
5,0 x 40	*	*	*	200	1.800
5,0 x 45	*	*	*	200	1.200
5,0 x 50	*	*	*	200	1.200
5,0 x 60	*	*	*	100	600
5,0 x 70	*	*	*	100	900

Especificaciones
en pág. 146

LOTU[®]

The fixing brand





Rosca doble hilo

Double thread wood screw
Vis a bois a deux filets



Especificaciones en pág. 146



800/1TZ

Ranura longitudinal
Punta atornillador
1/4" x 25

Ø Tornillo (mm)

2,40	0,6 x 4,5
2,70 - 3,00	0,8 x 5,5
3,50 - 4,00	1,0 x 5,5
4,50 - 5,00	1,2 x 6,5

Especificaciones en pág. 134

RAN - 72

Cabeza plana ranura

Slotted countersunk head double thread wood screw

Vis a bois a deux filets tête fraisée fendue

Medida Size Dimension	Cincado Zinc plated Zingué	Latonado Brassed coating Laitonné	Envasado Packing Emboîtage	Embalaje Carton Emballage
mm.	€/1.000	€/1.000	Und.	Und.
2,4 x 10	*	*	1.000	18.000
2,4 x 15	*	*	1.000	18.000
2,4 x 17	*	*	1.000	18.000
2,7 x 10	*	*	1.000	18.000
3,0 x 12	*	*	1.000	18.000
3,0 x 16	*	*	1.000	9.000
3,0 x 25	*	*	500	4.500
3,0 x 30	*	*	500	4.500
3,0 x 35	*	*	500	4.500
3,0 x 40	*	*	500	3.000
4,0 x 16	*	*	500	9.000
4,0 x 35	*	*	500	3.000
4,0 x 40	*	*	500	3.000
4,0 x 50	*	*	200	1.800
4,5 x 25	*	*	500	3.000
4,5 x 35	*	*	500	3.000
4,5 x 50	*	*	200	1.200
4,5 x 60	*	*	200	1.200
5,0 x 25	*	*	500	3.000
5,0 x 30	*	*	200	1.800
5,0 x 40	*	*	200	1.800
5,0 x 60	*	*	100	600

Consultar disponibilidad. Tornillo de fabricacion especial

Inquire stock availability

Consulter disponibilité

RED - 74

Cabeza redonda ranura

Slotted rounded head double thread wood screw

Vis a bois a deux filets tête ronde fendue

Medida Size Dimension	Cincado Zinc plated Zingué	Latonado Brassed coating Laitonné	Envasado Packing Emboîtage	Embalaje Carton Emballage
mm.	€/1.000	€/1.000	Und.	Und.
2,1 x 12	*	*	1.000	18.000
2,7 x 16	*	*	1.000	18.000
3,0 x 20	*	*	1.000	9.000
3,5 x 13	*	*	1.000	9.000
3,5 x 16	*	*	1.000	9.000
3,5 x 40	*	*	500	3.000
3,5 x 45	*	*	500	3.000
4,0 x 13	*	*	500	9.000
4,0 x 30	*	*	500	4.500
4,0 x 40	*	*	500	3.000
4,0 x 50	*	*	200	1.800
4,0 x 60	*	*	200	1.200
4,0 x 70	*	*	200	1.200
4,5 x 30	*	*	500	3.000
4,5 x 40	*	*	200	1.800
5,0 x 45	*	*	200	1.800

Consultar disponibilidad. Tornillo de fabricación especial

Inquire stock availability

Consulter disponibilité



Especificaciones en pág. 146



800/1TZ

Ranura longitudinal

Punta atornillador

1/4" x 25

Ø Tornillo (mm)



2,40	0,6 x 4,5
2,70 - 3,00	0,8 x 5,5
3,50 - 4,00	1,0 x 5,5
4,50 - 5,00	1,2 x 6,5

Especificaciones en pág. 134

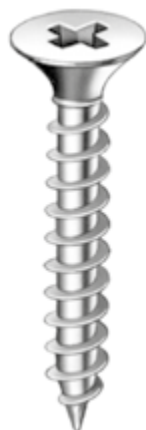

Especificaciones en pág. 146

PHI - 82

Cabeza plana philips

Philips countersunk head double thread wood screw

Vis a bois a deux filets tête fraisée philips

Medida Size Dimension	Cincado Zinc plated Zingué	Envasado Packing Emboîtage	Embalaje Carton Emballage
mm.	€/1.000	Und.	Und.
3,5 x 15	*	1.000	9.000
3,5 x 16	*	1.000	9.000
3,5 x 30	*	500	4.500
3,5 x 35	*	500	4.500
4,0 x 13	*	500	9.000
4,0 x 15	*	500	9.000
4,0 x 35	*	500	3.000

Consultar disponibilidad. Tornillo de fabricacion especial

Inquire stock availability

Consulter disponibilité



Especificaciones en pág. 146

PHI - 81

Cabeza alomada philips

Philips pan head double thread wood screw

Vis a bois a deux filets tête cylindrique bombée large philips

Medida Size Dimension	Cincado Zinc plated Zingué	Envasado Packing Emboîtage	Embalaje Carton Emballage
mm.	€/1.000	Und.	Und.
3,5 x 15	*	1.000	9.000
3,5 x 16	*	1.000	9.000
4,0 x 12	*	500	9.000
4,0 x 13	*	500	9.000
4,0 x 15	*	500	9.000
4,0 x 16	*	500	9.000
4,0 x 17	*	500	9.000
4,0 x 30	*	500	4.500
4,0 x 35	*	500	3.000
4,0 x 40	*	500	3.000
4,0 x 45	*	200	1.800
4,5 x 17	*	500	4.500
4,5 x 40	*	200	1.800
5,0 x 40	*	200	1.800

Consultar disponibilidad. Tornillo de fabricacion especial

Inquire stock availability

Consulter disponibilité



851/1TH Extra Dura

Cruz philips
Punta atornillador
1/4" x 25



851/4TH Extra Dura

Cruz philips
Punta atornillador
1/4" x 50

Ø Tornillo (mm)



3,50 - 4,50

PH-2

5,00

PH-3

Especificaciones en pág. 134

GSB - 83

Cabeza gota sebo philips

Philips raised countersunk head double thread wood screw

Vis a bois a deux filets tête fraisée bombée philips

Medida Size Dimension	Cincado Zinc plated Zingué	Envasado Packing Emboîtage	Embalaje Carton Emballage
mm.	€/1.000	Und.	Und.
3,5 x 30	*	500	4.500
4,0 x 20	*	500	4.500
4,0 x 30	*	500	4.500
4,0 x 45	*	200	1.800

Consultar disponibilidad. Tornillo de fabricación especial

Inquire stock availability

Consulter disponibilité



Especificaciones en pág. 146



851/1 TH Extra Dura

Cruz philips
Punta atornillador
1/4" x 25



851/4 TH Extra Dura

Cruz philips
Punta atornillador
1/4" x 50

Ø Tornillo (mm)



3,50 - 4,50

PH-2

5,00

PH-3

Especificaciones en pág. 134

LOTU[®]

The fixing brand



A low-angle, upward-looking photograph of a wooden ceiling. The ceiling is composed of numerous parallel wooden planks, some of which are secured by metal brackets or screws. The lighting is bright, highlighting the natural grain and texture of the wood. A white, rounded rectangular graphic element is overlaid on the right side of the image, containing text.

Carpintería madera

Special wood screws - various

Vis special pour bois - divers



CM - ENS 5

Tornillo ensamblaje N° 5

Ø 5 mm. furniture assembly screw
Vis pour assemblage a bois Ø 5 mm.

Medida Size Dimension	Cincado Zinc plated Zingué	Bicromatado Yellow Zinc plated Bichromaté	Cincado Negro Black Zinc plated Zingué Noir	Envasado Packing Emboîtage	Embalaje Carton Emballage
mm.	€/1.000	€/1.000	€/1.000	Und.	Und.
5 x 40	*	*	*	200	1.800
5 x 50	*	*	*	200	1.800



TP - ENS 5

Tapón plástico para tornillo ensamblaje N° 5

Plastic cap for furniture assembly screw
Bouchon a plastique pour vis pour assemblage a bois

Colores disponibles
Colours / Couleurs



Color Colour Couleur	Precio Price Prix	Envasado Packing Emboîtage	Embalaje Carton Emballage
	€/1.000	Und.	Und.
Blanco-White-Blanc	*	1.000	9.000
Negro-Black-Noir *	*	1.000	9.000
Marrón-Brown-Marron	*	1.000	9.000
Roble-Oak colour-Rouvre*	*	1.000	9.000



CM - ENP 5

Tornillo ensamblaje punta N° 5

Ø 5 mm. furniture assembly screw
Vis pour assemblage a bois Ø 5 mm.

Medida Size Dimension	Cincado Zinc plated Zingué	Bicromatado Yellow Zinc plated Bichromaté	Cincado Negro Black Zinc plated Zingué Noir	Envasado Packing Emboîtage	Embalaje Carton Emballage
mm.	€/1.000	€/1.000	€/1.000	Und.	Und.
5 x 50	*	*	*	200	1.800



Estrías bajo la cabeza para asegurar un fuerte amarre al avellanar la propia madera. Mayor profundidad de entalla

Nibs under head
Deeper recess



Rosca 40°
40° thread profile



Punta 25°
Sharp 25° point

CM - ENS 7

Tornillo ensamblaje N°7

Ø 7 mm. furniture assembly screw

Vis pour assemblage a bois Ø 7 mm.

Medida Size Dimension	Cincado Zinc plated Zingué	Bicromatado Yellow Zinc plated Bichromaté	Cincado Negro Black Zinc plated Zingué Noir	Envasado Packing Emboîtage	Embalaje Carton Emballage
mm.	€/1.000	€/1.000	€/1.000	Und.	Und.
7 x 40	*	*	*	200	1.200
7 x 50	*	*	*	100	900



TP - ENS 7

Tapón plástico para tornillo ensamblaje N°7

Plastic cap for furniture assembly screw

Bouchon a plastique pour vis pour assemblage a bois

Color Colour Couleur	Precio Price Prix	Envasado Packing Emboîtage	Embalaje Carton Emballage
	€/1.000	Und.	Und.
Blanco-White-Blanc	*	1.000	9.000
Marrón-Brown-Marron	*	1.000	9.000



Colores disponibles Colours / Couleurs





867/1TZ 
Entalla TX
Punta atornillador
1/4" x 25



867/4TZ 
Entalla TX
Punta atornillador
1/4" x 50

Ø Tornillo (mm) 

3,50 - 4,00	TX -20
4,50 - 5,00	TX -25

Especificaciones en pág. 134

CM - TX

Tornillo ensamblaje TX estrías rosca parcial

TX countersunk head chipboard screw partial thread

Vis a bois aglomerée filet 400 tête fraisée TX filetée partielle

Medida Size Dimension	Bicromatado Yellow Zinc plated Bichromaté	Envasado Packing Emboîtage	Embalaje Carton Emballage
mm.	€/1.000	Und.	Und.
4,0 x 30 (R-20)	*	500	4.500
4,5 x 30 (R-18)	*	500	3.000
4,5 x 45 (R-35)	*	200	1.800
4,5 x 50 (R-35)	*	200	1.200
5,0 x 60 (R-45)	*	100	600
5,0 x 80 (R-54)	*	100	600



CM - GSB

Gota sebo pozi rosca madera doble hilo

Pozi raised countersunk head double thread wood screw

Vis a bois a deux filets fraisée bombée pozi

Medida Size Dimension	Niquelado Nickel plated Nickelé	Envasado Packing Emboîtage	Embalaje Carton Emballage
mm.	€/1.000	Und.	Und.
3,5 x 15	*	1.000	9.000
3,5 x 17	*	1.000	9.000
3,5 x 20	*	1.000	9.000
4,0 x 15	*	500	4.500
4,0 x 17	*	500	4.500
4,0 x 20	*	500	4.500

TIR - PZ

Tornillo tirador cabeza alomada pozi combinada con arandela

Pozi slotted flange pan head machine screw

Vis a métaux tête poelier pozi fendue



Medida Size Dimension	Cincado Zinc plated Zingué	Envasado Packing Emboîtage	Embalaje Carton Emballage
mm.	€/1.000	Und.	Und.
M-4 x 10	*	200	3.600
M-4 x 15	*	500	4.500
M-4 x 20	*	500	4.500
M-4 x 22	*	500	4.500
M-4 x 25	*	500	4.500
M-4 x 27	*	500	3.000
M-4 x 30	*	500	3.000
M-4 x 35	*	200	1.800
M-4 x 40	*	200	1.800
M-4 x 45	*	200	1.800
M-4 x 50	*	100	900

TIR - RAN

Tornillo tirador ranura cruzada

Special round double slotted head machine screw

Vis a métaux tête ronde large fendue



Medida Size Dimension	Niquelado Nickel plated Nickelé	Envasado Packing Emboîtage	Embalaje Carton Emballage
mm.	€/1.000	Und.	Und.
M-4 x 11	*	500	4.500
M-4 x 13	*	500	4.500
M-4 x 15	*	500	4.500
M-4 x 20	*	500	4.500
M-4 x 22	*	500	4.500
M-4 x 25	*	500	4.500
M-4 x 27	*	500	3.000
M-4 x 30	*	500	3.000
M-4 x 35	*	200	1.800
M-4 x 40	*	200	1.800
M-4 x 45	*	200	1.800
M-4 x 50	*	200	1.200
M-4 x 55	*	200	1.200
M-4 x 60	*	200	1.200



TIR MULTI

Cabeza alomada pozi + ranura rosca métrica

Combi pan head, metric thread

Vis a métaux, combi tête

Medida Size Dimension	Cincado Zinc plated Zingué	Bicromatado Yellow Zinc plated Bichromaté	Niquelado Nickel plated Nickelé	Envasado Packing Emboîtage	Embalaje Carton Emballage
mm.	€/1.000	€/1.000	€/1.000	Und.	Und.
M-4 x 45	*	*	*	200	1.800



SILLA

Tornillo para silla y mueble metálico W-3/16

W-3/16 metallic furniture screw

Vis pour meuble métallique filet whitworth W-3/16

Medida Size Dimension	Niquelado Nickel plated Nickelé	Envasado Packing Emboîtage	Embalaje Carton Emballage
mm.	€/1.000	Und.	Und.
W3/16 x 10	*	200	3.600
W3/16 x 15	*	200	1.800
W3/16 x 20	*	200	1.800
W3/16 x 25	*	200	1.800
W3/16 x 30	*	200	1.800
W3/16 x 35	*	200	1.200
W3/16 x 40	*	200	1.200
W3/16 x 45	*	200	1.200
W3/16 x 50	*	200	1.200
W3/16 x 60	*	100	900
W3/16 x 70	*	100	900
TUERCA	*	1.000	9.000

CM - ARPZ

Cabeza alomada pozi con arandela estampada rosca madera un hilo 40°

Pozi flange pan head chipboard screw

Vis a bois aglomerée 400 tête poelier pozi

Medida Size Dimension	Cincado Zinc plated Zingué	Bicromatado Yellow Zinc plated Bichromaté	Envasado Packing Emboîtage	Embalaje Carton Emballage
mm.	€/1.000	€/1.000	Und.	Und.
3,0 x 16	*	*	1.000	9.000
3,0 x 20	*	*	1.000	9.000
3,0 x 25	*	*	500	4.500
3,0 x 30	*	*	500	4.500
3,5 x 16	*	*	1.000	9.000
3,5 x 20	*	*	1.000	9.000
3,5 x 25	*	*	500	4.500
3,5 x 30	*	*	500	4.500
4,0 x 16	*	*	500	4.500
4,0 x 20	*	*	500	4.500
4,0 x 25	*	*	500	4.500
4,0 x 30	*	*	500	4.500
4,0 x 35	*	*	500	3.000
4,0 x 40	*	*	500	3.000



855/1 TH Extra Dura

Cruz pozidriv
Punta atornillador
1/4" x 25



855/4 TH Extra Dura

Cruz pozidriv
Punta atornillador
1/4" x 50

Ø Tornillo (mm)



3,00

PZ-1

3,50 - 4,00

PZ-2

Especificaciones en pág. 134

39

TORNILLO INVIOLEABLE

Tamper proof screw

Vis inviolablei

Medida Size Dimension	Cincado Zinc plated Zingué	Cincado Negro Black Zinc plated Zingué Noir	Envasado Packing Emboîtage	Embalaje Carton Emballage
mm.	€/1.000	€/1.000	Und.	Und.
7 x 30	*	*	100	900
7 x 40	*	*	100	900
7 x 50	*	*	100	600
7 x 60	*	*	100	600
7 x 70	*	*	100	600
7 x 80	*	*	100	600
7 x 90	*	*	100	600

Incluimos punta de montaje T - 40 y tapón de Zamak

Including T - 40 driving bit and Zamak button

Avec bouchon Zamak et bit T - 40





DIN 571

Cabeza hexagonal rosca tirafondo cincado

Hexagon head wood screw zinc plated coating

Tête hexagonale tire-fond zingué

Medida Size Dimension	Cincado Zinc plated Zingué	Envasado Packing Emboîtage	Embalaje Carton Emballage
mm.	€/1.000	Und.	Und.
5 x 25	*	500	3.000
5 x 30	*	500	3.000
5 x 35	*	200	1.200
5 x 40	*	200	1.200
5 x 45	*	200	1.200
5 x 50	*	200	1.200
5 x 60	*	200	1.200
6 x 25	*	200	1.200
6 x 30	*	200	1.200
6 x 35	*	200	1.200
6 x 40	*	200	1.200
6 x 45	*	100	900
6 x 50	*	100	900
6 x 60	*	100	900
6 x 70	*	100	600
6 x 80	*	100	600
6 x 90	*	100	600
6 x 100	*	100	600
7 x 30	*	100	600
7 x 35	*	100	900
7 x 40	*	100	900
7 x 50	*	100	900
7 x 60	*	100	600
7 x 70	*	100	600
7 x 80	*	100	600
7 x 90	*	100	600
7 x 100	*	100	600
7 x 110	*	100	600
8 x 30	*	50	300
8 x 40	*	100	900
8 x 45	*	100	600
8 x 50	*	100	600
8 x 60	*	100	600
8 x 70	*	100	600
8 x 80	*	100	600
8 x 90	*	100	600
8 x 100	*	100	600
8 x 110	*	50	300
8 x 120	*	50	300
8 x 140	*	50	300
8 x 150	*	50	300

DIN 571**Cabeza hexagonal rosca tirafondo cincado**

Hexagon head wood screw zinc plated coating

Tête hexagonale tire-fond zingué



Medida Size Dimension	Cincado Zinc plated Zingué	Envasado Packing Emboîtage	Embalaje Carton Emballage
mm.	€/1.000	Und.	Und.
10 x 40	*	50	300
10 x 45	*	50	300
10 x 50	*	50	300
10 x 60	*	50	300
10 x 70	*	50	300
10 x 80	*	50	300
10 x 90	*	50	300
10 x 100	*	50	300
10 x 110	*	50	300
10 x 120	*	50	300
10 x 130	*	50	300
10 x 150	*	50	300
10 x 160	*	50	300
10 x 170	*	30	180
10 x 200	*	50	300
12 x 60	*		50
12 x 70	*	50	300
12 x 80	*	50	300
12 x 90	*	50	300
12 x 100	*	50	300
12 x 110	*	30	180
12 x 160	*	30	180
12 x 190	*	10	100
12 x 200	*	10	60

LOTU[®]

The fixing brand





Rosca métrica

Machine Screw

Vis a métaux



Especificaciones en pág. 146



800/1TZ

Ranura longitudinal
Punta atornillador
1/4" x 25

Ø Tornillo (mm)

M-3	0,8 x 5,5
M-4	1,0 x 5,5
M-5	1,2 x 6,5
M-6	1,6 x 8,0

Especificaciones en pág. 134

DIN 84 - 4.8

Cabeza cilíndrica ranura

Slotted cheese head machine screw

Vis a métaux tête cylindrique fendue

Medida Size Dimension	Cincado Zinc plated Zingué	Cincado Negro Black Zinc plated Zingué Noir	Envasado Packing Emboîtage	Embalaje Carton Emballage
mm.	€/1.000	€/1.000	Und.	Und.
M-3 x 6	*	*	500	9.000
M-3 x 8	*	*	500	9.000
M-3 x 10	*	*	500	9.000
M-3 x 12	*	*	500	9.000
M-3 x 15	*	*	500	9.000
M-3 x 20	*	*	500	9.000
M-3 x 25	*	*	500	4.500
M-3 x 30	*	*	500	4.500
M-3 x 35	*	*	200	3.600
M-3 x 40	*	*	200	3.600
M-4 x 6	*	*	500	9.000
M-4 x 8	*	*	500	9.000
M-4 x 10	*	*	500	4.500
M-4 x 12	*	*	500	4.500
M-4 x 15	*	*	500	4.500
M-4 x 20	*	*	500	4.500
M-4 x 25	*	*	500	3.000
M-4 x 30	*	*	500	3.000
M-4 x 35	*	*	200	1.800
M-4 x 40	*	*	200	1.800
M-4 x 45	*	*	200	1.800
M-4 x 50	*	*	200	1.800
M-4 x 60	*	*	200	1.200
M-5 x 8	*	*	200	3.600
M-5 x 10	*	*	200	3.600
M-5 x 12	*	*	200	3.600
M-5 x 15	*	*	200	3.600
M-5 x 20	*	*	200	1.800
M-5 x 25	*	*	200	1.800
M-5 x 30	*	*	200	1.800
M-5 x 35	*	*	200	1.800
M-5 x 40	*	*	200	1.800
M-5 x 45	*	*	200	1.200
M-5 x 50	*	*	200	1.200
M-5 x 60	*	*	100	900
M-5 x 70	*	*	100	900
M-6 x 8	*	*	200	1.800
M-6 x 10	*	*	200	3.600
M-6 x 12	*	*	200	1.800
M-6 x 15	*	*	200	1.800
M-6 x 20	*	*	200	1.800
M-6 x 25	*	*	200	1.800
M-6 x 30	*	*	200	1.200
M-6 x 35	*	*	200	1.200
M-6 x 40	*	*	200	1.200
M-6 x 45	*	*	100	600
M-6 x 50	*	*	100	600
M-6 x 60	*	*	100	600
M-6 x 70	*	*	100	600

DIN 963 - 4.8

Cabeza plana ranura

Slotted countersunk head machine screw

Vis a métaux tête fraisée fendue



Especificaciones
en pág. 146



800/1TZ

Ranura longitudinal
Punta atornillador
1/4" x 25

Ø Tornillo (mm)



M-3	0,8 x 5,5
M-4	1,0 x 5,5
M-5	1,2 x 6,5
M-6	1,6 x 8,0

Especificaciones en pág. 134

Medida Size Dimension	Cincado Zinc plated Zingué	Cincado Negro Black Zinc plated Zingué Noir	Invasado Packing Emboîtage	Embalaje Carton Emballage
mm.	€/1.000	€/1.000	Und.	Und.
M-3 x 6	*	*	500	9.000
M-3 x 8	*	*	500	9.000
M-3 x 10	*	*	500	9.000
M-3 x 12	*	*	500	9.000
M-3 x 15	*	*	500	9.000
M-3 x 20	*	*	500	9.000
M-3 x 25	*	*	500	4.500
M-3 x 30	*	*	500	4.500
M-3 x 35	*	*	200	3.600
M-3 x 40	*	*	200	3.600
M-4 x 8	*	*	500	9.000
M-4 x 10	*	*	500	4.500
M-4 x 12	*	*	500	4.500
M-4 x 16	*	*	500	4.500
M-4 x 20	*	*	500	4.500
M-4 x 25	*	*	500	3.000
M-4 x 30	*	*	500	3.000
M-4 x 35	*	*	200	1.800
M-4 x 40	*	*	200	1.800
M-4 x 45	*	*	200	1.800
M-4 x 50	*	*	200	1.800
M-4 x 60	*	*	200	1.200
M-5 x 8	*	*	200	3.600
M-5 x 10	*	*	200	3.600
M-5 x 12	*	*	200	3.600
M-5 x 16	*	*	200	3.600
M-5 x 20	*	*	200	1.800
M-5 x 25	*	*	200	1.800
M-5 x 30	*	*	200	1.800
M-5 x 35	*	*	200	1.800
M-5 x 40	*	*	200	1.800
M-5 x 45	*	*	200	1.200
M-5 x 50	*	*	200	1.200
M-5 x 60	*	*	100	900
M-6 x 10	*	*	200	3.600
M-6 x 12	*	*	200	1.800
M-6 x 15	*	*	200	1.800
M-6 x 20	*	*	200	1.800
M-6 x 25	*	*	200	1.800
M-6 x 30	*	*	200	1.200
M-6 x 35	*	*	200	1.200
M-6 x 40	*	*	200	1.200
M-6 x 45	*	*	100	600
M-6 x 50	*	*	100	600
M-6 x 60	*	*	100	600



Especificaciones en pág. 146



851/1TZ
Cruz philips
Punta atornillador
1/4" x 25



851/4TZ
Cruz philips
Punta atornillador
1/4" x 50

Ø Tornillo (mm)



M-3	PH-1
M-3,5 - M-5	PH-2
M-6	PH-3

Especificaciones en pág. 134

DIN 965 - 4.8

Cabeza plana philips

Philips countersunk head machine screw

Vis a métaux tête fraisée philips

Medida Size Dimension	Cincado Zinc plated Zingué	Cincado Negro Black Zinc plated Zingué Noir	Envasado Packing Emboítage	Embalaje Carton Emballage
mm.	€/1.000	€/1.000	Und.	Und.
M-3 x 6	*	*	500	9.000
M-3 x 8	*	*	500	9.000
M-3 x 10	*	*	500	9.000
M-3 x 12	*	*	500	9.000
M-3 x 16	*	*	500	9.000
M-3 x 20	*	*	500	9.000
M-3 x 25	*	*	500	4.500
M-3 x 30	*	*	500	4.500
M-4 x 6	*	*	500	9.000
M-4 x 8	*	*	500	9.000
M-4 x 10	*	*	500	4.500
M-4 x 12	*	*	500	4.500
M-4 x 15	*	*	500	4.500
M-4 x 20	*	*	500	4.500
M-4 x 25	*	*	500	3.000
M-4 x 30	*	*	500	3.000
M-4 x 35	*	*	200	1.800
M-4 x 40	*	*	200	1.800
M-4 x 45	*	*	200	1.800
M-4 x 50	*	*	200	1.800
M-5 x 8	*	*	200	3.600
M-5 x 10	*	*	200	3.600
M-5 x 12	*	*	200	3.600
M-5 x 15	*	*	200	3.600
M-5 x 20	*	*	200	1.800
M-5 x 25	*	*	200	1.800
M-5 x 30	*	*	200	1.800
M-5 x 35	*	*	200	1.800
M-5 x 40	*	*	200	1.800
M-5 x 45	*	*	200	1.200
M-5 x 50	*	*	200	1.200
M-5 x 60	*	*	100	900
M-5 x 70	*	*	100	900
M-6 x 10	*	*	200	3.600
M-6 x 12	*	*	200	1.800
M-6 x 15	*	*	200	1.800
M-6 x 20	*	*	200	1.800
M-6 x 25	*	*	200	1.800
M-6 x 30	*	*	200	1.200
M-6 x 35	*	*	200	1.200
M-6 x 40	*	*	200	1.200
M-6 x 45	*	*	100	600
M-6 x 50	*	*	100	600
M-6 x 60	*	*	100	600
M-6 x 70	*	*	100	600

DIN 7985 - 4.8

Cabeza alomada philips

Philips pan head machine screw

Vis a métaux tête cylindrique bombée large philips

Medida Size Dimension	Cincado Zinc plated Zingué	Cincado Negro Black Zinc plated Zingué Noir	Envasado Packing Emboîtage	Embalaje Carton Emballage
mm.	€/1.000	€/1.000	Und.	Und.
M-3 x 5	*	*	500	9.000
M-3 x 6	*	*	500	9.000
M-3 x 8	*	*	500	9.000
M-3 x 10	*	*	500	9.000
M-3 x 12	*	*	500	9.000
M-3 x 15	*	*	500	9.000
M-3 x 20	*	*	500	9.000
M-3 x 25	*	*	500	4.500
M-3 x 30	*	*	500	4.500
M-4 x 5	*	*	500	9.000
M-4 x 6	*	*	500	9.000
M-4 x 8	*	*	500	9.000
M-4 x 10	*	*	500	4.500
M-4 x 12	*	*	500	4.500
M-4 x 15	*	*	500	4.500
M-4 x 20	*	*	500	4.500
M-4 x 25	*	*	500	3.000
M-4 x 30	*	*	500	3.000
M-4 x 35	*	*	200	1.800
M-4 x 40	*	*	200	1.800
M-4 x 45	*	*	200	1.800
M-4 x 50	*	*	200	1.800
M-5 x 6	*	*	200	3.600
M-5 x 8	*	*	200	3.600
M-5 x 10	*	*	200	3.600
M-5 x 12	*	*	200	3.600
M-5 x 15	*	*	200	3.600
M-5 x 20	*	*	200	1.800
M-5 x 25	*	*	200	1.800
M-5 x 30	*	*	200	1.800
M-5 x 35	*	*	200	1.800
M-5 x 40	*	*	200	1.800
M-5 x 45	*	*	200	1.200
M-5 x 50	*	*	200	1.200
M-5 x 60	*	*	100	900
M-5 x 70	*	*	100	900
M-6 x 8	*	*	200	1.800
M-6 x 10	*	*	200	3.600
M-6 x 12	*	*	200	1.800
M-6 x 15	*	*	200	1.800
M-6 x 20	*	*	200	1.800
M-6 x 25	*	*	200	1.800
M-6 x 30	*	*	200	1.200
M-6 x 35	*	*	200	1.200
M-6 x 40	*	*	200	1.200
M-6 x 45	*	*	100	600
M-6 x 50	*	*	100	600
M-6 x 60	*	*	100	600
M-6 x 70	*	*	100	600



Especificaciones
en pág. 146



851/1TZ
Cruz philips
Punta atornillador
1/4" x 25



851/4TZ
Cruz philips
Punta atornillador
1/4" x 50

Ø Tornillo (mm)	+
M-3	PH-1
M-3,5 - M-5	PH-2
M-6	PH-3

Especificaciones en pág. 134



Especificaciones en pág. 146



869/4
Cabeza Hexagonal
Aprieta-tuercas
1/4" x 65



869/4 M
Cabeza Hexagonal
Aprieta-tuercas magnético
1/4" x 65

Ø Tornillo (mm)

M-4	SW-7
M-5	SW-8
M-6	SW-10
M-8	SW-13
M-10	SW-17
M-12	SW-19
M-14	SW-22
M-16	SW-24
M-18	SW-27

Especificaciones en pág. 134

DIN 933 - 8.8

Cabeza hexagonal

Hexagonal head machine screw

Vis a métaux tête hexagonale

Medida Size Dimension	Cincado Zinc plated Zingué	Envasado Packing Emboitage	Embalaje Carton Emballage
mm.	€/1.000	Und.	Und.
M-4 x 10	*	500	9.000
M-4 x 16	*	500	4.500
M-4 x 20	*	500	3.000
M-4 x 25	*	500	3.000
M-4 x 30	*	500	3.000
M-4 x 35	*	200	1.800
M-4 x 40	*	200	1.800
M-5 x 8	*	200	3.600
M-5 x 10	*	200	3.600
M-5 x 16	*	200	3.600
M-5 x 20	*	200	1.800
M-5 x 25	*	200	1.800
M-5 x 30	*	200	1.800
M-5 x 35	*	200	1.800
M-5 x 40	*	200	1.800
M-5 x 50	*	200	1.200
M-5 x 60	*	100	900
M-6 x 10	*	200	1.800
M-6 x 12	*	200	1.800
M-6 x 15	*	200	1.800
M-6 x 20	*	200	1.200
M-6 x 25	*	200	1.200
M-6 x 30	*	200	1.200
M-6 x 35	*	200	1.200
M-6 x 40	*	200	1.800
M-6 x 50	*	100	600
M-6 x 50	*	100	600
M-8 x 16	*	200	1.200
M-8 x 20	*	200	1.800
M-8 x 25	*	200	1.200
M-8 x 30	*	200	1.200
M-8 x 40	*	100	600
M-8 x 50	*	50	450
M-8 x 60	*	50	450
M-8 x 70	*	50	450
M-8 x 80	*	50	300
M-8 x 100	*	50	300
M-10 x 16	*	200	600
M-10 x 20	*	200	600
M-10 x 30	*	50	450
M-10 x 40	*	50	450
M-10 x 50	*	50	450
M-10 x 60	*	50	300
M-10 x 70	*	50	300
M-10 x 80	*	50	300
M-10 x 90	*	50	150
M-10 x 100	*	50	300

DIN 933 - 8.8

Cabeza hexagonal

Hexagonal head machine screw

Vis a métaux tête hexagonale

Medida Size Dimension	Cincado Zinc plated Zingué	Envasado Packing Emboîtage	Embalaje Carton Emballage
mm.	€/1.000	Und.	Und.
M-12 x 20	*	60	360
M-12 x 25	*	60	360
M-12 x 30	*	50	300
M-12 x 40	*	50	150
M-12 x 50	*	50	300
M-12 x 60	*	25	150
M-12 x 70	*	25	150
M-12 x 80	*	20	120
M-12 x 90	*	20	120
M-12 x 100	*	20	120
M-14 x 30	*	36	216
M-14 x 40	*	36	216
M-14 x 50	*	36	216
M-14 x 60	*	24	144
M-14 x 70	*	20	120
M-14 x 80	*	20	120
M-16 x 30	*	30	90
M-16 x 40	*	30	90
M-16 x 50	*	30	90
M-16 x 60	*	20	60
M-16 x 70	*	20	60
M-16 x 80	*	15	45
M-16 x 90	*	15	90
M-16 x 100	*	12	72
M-18 x 40	*		80
M-18 x 50	*		80
M-18 x 60	*		80
M-18 x 70	*		75
M-18 x 80	*		75



Especificaciones
en pág. 146



869/4

Cabeza Hexagonal
Aprieta-tuercas
1/4" x 65



869/4 M

Cabeza Hexagonal
Aprieta-tuercas magnético
1/4" x 65

Ø Tornillo (mm)



M-4	SW-7
M-5	SW-8
M-6	SW-10
M-8	SW-13
M-10	SW-17
M-12	SW-19
M-14	SW-22
M-16	SW-24
M-18	SW-27

Especificaciones en pág. 134



Especificaciones en pág. 146



869/4
Cabeza Hexagonal
Aprieta-tuercas
1/4" x 65



869/4 M
Cabeza Hexagonal
Aprieta-tuercas magnético
1/4" x 65

Ø Tornillo (mm)



M-10	SW-17
M-12	SW-19
M-14	SW-22
M-16	SW-24
M-18	SW-27

Especificaciones en pág. 134

DIN 931 - 8.8

Cabeza hexagonal

Hexagonal head machine screw

Vis a métaux tête hexagonale

Medida Size Dimension	Cincado Zinc plated Zingué	Envasado Packing Emboitage	Embalaje Carton Emballage
mm.	€/1.000	Und.	Und.
M-10 x 100 ZIN	*	50	300
M-10 x 120 ZIN	*		80
M-10 x 140 ZIN	*		80
M-10 x 60 ZIN	*	50	300
M-10 x 80 ZIN	*	50	300
M-12 x 100 ZIN	*	20	120
M-12 x 120 ZIN	*		80
M-12 x 140 ZIN	*		80
M-14 x 100 ZIN	*	18	108
M-14 x 120 ZIN	*		60
M-14 x 140 ZIN	*		60
M-14 x 160 ZIN	*		60
M-14 x 80 ZIN	*	20	120
M-16 x 100 ZIN	*	12	72
M-16 x 120 ZIN	*		50
M-16 x 140 ZIN	*		25
M-16 x 160 ZIN	*		25
M-16 x 80 ZIN	*	15	90
M-18 x 100 ZIN	*		50
M-18 x 120 ZIN	*		50
M-18 x 140 ZIN	*		25
M-18 x 160 ZIN	*		25
M-18 x 180 ZIN	*		25
M-18 x 200 ZIN	*		25

DIN 912 - 8.8

Cabeza cilíndrica allen

Cylindrical head socket screw

Tête cylindrique six pans creux

Medida Size Dimension	Cincado Zinc plated Zingué	Envasado Packing Emboîtage	Embalaje Carton Emballage
mm.	€/1.000	Und.	Und.
M-4 x 16	*	500	4.500
M-5 x 16	*	200	3.600
M-5 x 20	*	200	1.800
M-5 x 25	*	200	1.800
M-6 x 10	*	200	3.600
M-6 x 12	*	200	3.600
M-6 x 16	*	200	1.800
M-6 x 20	*	200	1.800
M-6 x 25	*	200	1.800
M-8 x 16	*	100	900
M-8 x 20	*	100	900
M-8 x 25	*	100	900
M-8 x 40	*	100	600
M-8 x 60	*	100	600



Especificaciones en pág. 146



840/1TZ
Entalla Allen
Punta atornillador
1/4" x 25

Ø Tornillo (mm)



M-4	3
M-5	4
M-6	5
M-8	6

Especificaciones en pág. 134

VARILLA ROSCADA

Clase 4.8

Threaded rod

Tige filetée

Medida Size Dimension	Cincado Zinc plated Zingué	Envasado Packing Emboîtage	Embalaje Carton Emballage
mm.	€/100	Und.	Und.
M-4	*	200	200
M-5	*	100	100
M-6	*	100	100
M-8	*	50	50
M-10	*	25	25
M-12	*	20	20
M-14	*	20	20
M-16	*	10	10
M-18	*	10	10
M-20	*	10	10

Medida Size Dimension	Cincado Zinc plated Zingué	Envasado Packing Emboîtage	Embalaje Carton Emballage
mm.	€/100	Und.	Und.
M-6 x 2.000	*	50	50
M-8 x 2.000	*	25	25





Especificaciones en pág. 146

TUERCA DIN 934

Hexagonal nuts
Écrou hexagonale

Medida Size Dimension	Cincado Zinc plated Zingué	Envasado Packing Emboîtage	Embalaje Carton Emballage
mm.	€/1.000	Und.	Und.
M-3	*	1.000	18.000
M-4	*	500	9.000
M-5	*	500	9.000
M-6	*	500	9.000
M-8	*	200	3.600
M-10	*	100	900
M-12	*	100	900
M-14	*	100	900
M-16	*	50	450
M-18	*	50	450
M-20	*	25	225



Especificaciones en pág. 146

TUERCA DIN 934 INOXIDABLE

Stainless steel hexagonal nuts
Écrou hexagonale inoxydable

Medida Size Dimension	Inoxidable Stainless Inoxydable	Envasado Packing Emboîtage	Embalaje Carton Emballage
mm.	€/1.000	Und.	Und.
M-6	*	100	1.800
M-8	*	100	1.800
M-10	*	100	1.800



Especificaciones en pág. 146

TUERCA DIN 985 AUTOBLOCANTE

Self-locking hexagonal nuts
Écrou hexagonale autobloquant

Medida Size Dimension	Cincado Zinc plated Zingué	Envasado Packing Emboîtage	Embalaje Carton Emballage
mm.	€/1.000	Und.	Und.
M-4	*	500	9.000
M-6	*	500	4.500
M-8	*	200	3.600
M-10	*	200	1.800

TUERCA DIN 6923

Hexagonal nuts
Écrou hexagonale

Medida Size Dimension	Cincado Zinc plated Zingué	Envasado Packing Emboîtage	Embalaje Carton Emballage
mm.	€/1.000	Und.	Und.
M-4	*	1.000	18.000
M-6	*	1.000	18.000
M-8	*	1.000	18.000
M-10	*	1.000	18.000



Especificaciones
en pág. 146

TUERCA DIN 315 MARIPOSA

Hexagonal nuts
Écrou oreilles

Medida Size Dimension	Cincado Zinc plated Zingué	Envasado Packing Emboîtage	Embalaje Carton Emballage
mm.	€/1.000	Und.	Und.
M-4	*	100	1.800
M-6	*	100	1.800
M-8	*	100	1.800
M-10	*	100	900



Especificaciones
en pág. 146

ARANDELA DIN 125 A

Washer
Rondelle

Medida Size Dimension	Cincado Zinc plated Zingué	Envasado Packing Emboîtage	Embalaje Carton Emballage
mm.	€/1.000	Und.	Und.
M-3	*	2000	36.000
M-4	*	500	9.000
M-5	*	500	9.000
M-6	*	500	9.000
M-8	*	500	4.500
M-10	*	200	1.800
M-12	*	200	1.800
M-14	*	100	900
M-16	*	100	900
M-18	*	100	900
M-20	*	100	900



Especificaciones
en pág. 146



Especificaciones
en pág. 146

ARANDELA DIN 9021

Washer
Rondelle

Medida Size Dimension	Cincado Zinc plated Zingué	Envasado Packing Emboitage	Embalaje Carton Emballage
mm.	€/1.000	Und.	Und.
M-3	*	500	9.000
M-4	*	500	9.000
M-5	*	500	9.000
M-6	*	500	9.000
M-8	*	500	4.500
M-10	*	200	1.800
M-12	*	50	450
M-14	*	50	450
M-16	*	25	225
M-18	*	25	225
M-20	*	20	180

54



Especificaciones
en pág. 146

ARANDELA DIN 9021 INOXIDABLE

Stainless steel washer
Rondelle inoxydable

Medida Size Dimension	Inoxidable Stainless Inoxydable	Envasado Packing Emboitage	Embalaje Carton Emballage
mm.	€/1.000	Und.	Und.
M-6	*	100	800
M-8	*	100	800
M-10	*	100	900



Especificaciones
en pág. 146

ARANDELA DIN 127 B

Washer
Rondelle

Medida Size Dimension	Cincado Zinc plated Zingué	Envasado Packing Emboitage	Embalaje Carton Emballage
mm.	€/1.000	Und.	Und.
M-3	*	2000	36.000
M-4	*	500	9.000
M-5	*	500	9.000
M-6	*	500	9.000
M-8	*	500	4.500
M-10	*	200	1.800

DIN 7500 C

Cabeza alomada philips rosca trilobular autorroscante

Philips pan head trilobular thread screw

Vis a métaux autotaraudeuse tête cylindrique bombée large philips

Medida Size Dimension	Cincado Zinc plated Zingué	Embalaje Carton Emballage
mm.	€/1.000	
M-3 x 5	*	Ganel - Bulk - Vrac
M-3 x 6	*	Ganel - Bulk - Vrac
M-3 x 7	*	Ganel - Bulk - Vrac
M-3 x 8	*	Ganel - Bulk - Vrac
M-3 x 10	*	Ganel - Bulk - Vrac
M-3 x 12	*	Ganel - Bulk - Vrac
M-3 x 15	*	Ganel - Bulk - Vrac
M-3 x 20	*	Ganel - Bulk - Vrac
M-3,5 x 5	*	Ganel - Bulk - Vrac
M-3,5 x 6	*	Ganel - Bulk - Vrac
M-3,5 x 7	*	Ganel - Bulk - Vrac
M-3,5 x 8	*	Ganel - Bulk - Vrac
M-3,5 x 10	*	Ganel - Bulk - Vrac
M-3,5 x 12	*	Ganel - Bulk - Vrac
M-3,5 x 15	*	Ganel - Bulk - Vrac
M-3,5 x 20	*	Ganel - Bulk - Vrac
M-4 x 6	*	Ganel - Bulk - Vrac
M-4 x 7	*	Ganel - Bulk - Vrac
M-4 x 8	*	Ganel - Bulk - Vrac
M-4 x 10	*	Ganel - Bulk - Vrac
M-4 x 12	*	Ganel - Bulk - Vrac
M-4 x 15	*	Ganel - Bulk - Vrac
M-4 x 20	*	Ganel - Bulk - Vrac
M-4 x 25	*	Ganel - Bulk - Vrac
M-5 x 6	*	Ganel - Bulk - Vrac
M-5 x 8	*	Ganel - Bulk - Vrac
M-5 x 10	*	Ganel - Bulk - Vrac
M-5 x 12	*	Ganel - Bulk - Vrac
M-5 x 15	*	Ganel - Bulk - Vrac
M-5 x 20	*	Ganel - Bulk - Vrac
M-5 x 25	*	Ganel - Bulk - Vrac
M-6 x 10	*	Ganel - Bulk - Vrac
M-6 x 12	*	Ganel - Bulk - Vrac
M-6 x 15	*	Ganel - Bulk - Vrac
M-6 x 20	*	Ganel - Bulk - Vrac
M-6 x 25	*	Ganel - Bulk - Vrac

* Consultar disponibilidad. Tornillo de fabricación especial

* Inquire stock availability

* Consulter disponibilité



Especificaciones en pág. 146

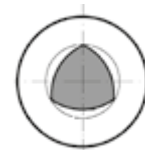

Corte transversal tornillo trilobular

Trilobular screw cross section
Section transversale de la vis trilobulaire



851/1TZ

Cruz philips
Punta atornillador
1/4" x 25



851/4TZ

Cruz philips
Punta atornillador
1/4" x 50

Ø Tornillo (mm)



M-3	PH-1
M-3,5 - M-5	PH-2
M-6	PH-3

Especificaciones en pág. 134



Especificaciones en pág. 146

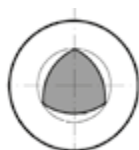

Corte transversal tornillo trilobular

Trilobular screw cross section
Section transversale de la vis trilobulaire



867/1 TZ

Entalla TX
Punta atornillador
1/4" x 25



867/4 TZ

Entalla TX
Punta atornillador
1/4" x 50

Ø Tornillo (mm)

Ø Tornillo (mm)	
M-3	TX-10
M-3,5	TX-15
M-4	TX-20
M-5	TX-25
M-6	TX-30

Especificaciones en pág. 134

DIN 7500 C TX

Cabeza alomada TX rosca trilobular autorroscante

TX pan head trilobular thread machine screw

Vis a métaux autotaraudeuse tête cylindrique bombée large TX

Medida Size Dimension	Cincado Zinc plated Zingué	Embalaje Carton Emballage
mm.	€/1.000	
M-3 x 5	*	Grael - Bulk - Vrac
M-3 x 6	*	Grael - Bulk - Vrac
M-3 x 7	*	Grael - Bulk - Vrac
M-3 x 8	*	Grael - Bulk - Vrac
M-3 x 10	*	Grael - Bulk - Vrac
M-3 x 12	*	Grael - Bulk - Vrac
M-3 x 15	*	Grael - Bulk - Vrac
M-3 x 20	*	Grael - Bulk - Vrac
M-3,5 x 5	*	Grael - Bulk - Vrac
M-3,5 x 6	*	Grael - Bulk - Vrac
M-3,5 x 7	*	Grael - Bulk - Vrac
M-3,5 x 8	*	Grael - Bulk - Vrac
M-3,5 x 10	*	Grael - Bulk - Vrac
M-3,5 x 12	*	Grael - Bulk - Vrac
M-3,5 x 15	*	Grael - Bulk - Vrac
M-3,5 x 20	*	Grael - Bulk - Vrac
M-4 x 6	*	Grael - Bulk - Vrac
M-4 x 7	*	Grael - Bulk - Vrac
M-4 x 8	*	Grael - Bulk - Vrac
M-4 x 10	*	Grael - Bulk - Vrac
M-4 x 12	*	Grael - Bulk - Vrac
M-4 x 15	*	Grael - Bulk - Vrac
M-4 x 20	*	Grael - Bulk - Vrac
M-4 x 25	*	Grael - Bulk - Vrac
M-5 x 6	*	Grael - Bulk - Vrac
M-5 x 8	*	Grael - Bulk - Vrac
M-5 x 10	*	Grael - Bulk - Vrac
M-5 x 12	*	Grael - Bulk - Vrac
M-5 x 15	*	Grael - Bulk - Vrac
M-5 x 20	*	Grael - Bulk - Vrac
M-5 x 25	*	Grael - Bulk - Vrac
M-6 x 10	*	Grael - Bulk - Vrac
M-6 x 12	*	Grael - Bulk - Vrac
M-6 x 15	*	Grael - Bulk - Vrac
M-6 x 20	*	Grael - Bulk - Vrac
M-6 x 25	*	Grael - Bulk - Vrac

* Consultar disponibilidad. Tornillo de fabricación especial

* Inquire stock availability

* Consulter disponibilité

DIN 7500 M

Cabeza plana philips rosca trilobular autorroscante

Philips countersunk head trilobular thread screw

Vis a métaux autotaraudeuse tête fraisée philips

Medida Size Dimension	Cincado Zinc plated Zingué	Embalaje Carton Emballage
mm.	€/1.000	
M-3 x 5	*	Ganel - Bulk - Vrac
M-3 x 6	*	Ganel - Bulk - Vrac
M-3 x 7	*	Ganel - Bulk - Vrac
M-3 x 8	*	Ganel - Bulk - Vrac
M-3 x 10	*	Ganel - Bulk - Vrac
M-3 x 12	*	Ganel - Bulk - Vrac
M-3 x 15	*	Ganel - Bulk - Vrac
M-3 x 20	*	Ganel - Bulk - Vrac
M-3,5 x 5	*	Ganel - Bulk - Vrac
M-3,5 x 6	*	Ganel - Bulk - Vrac
M-3,5 x 7	*	Ganel - Bulk - Vrac
M-3,5 x 8	*	Ganel - Bulk - Vrac
M-3,5 x 10	*	Ganel - Bulk - Vrac
M-3,5 x 12	*	Ganel - Bulk - Vrac
M-3,5 x 15	*	Ganel - Bulk - Vrac
M-3,5 x 20	*	Ganel - Bulk - Vrac
M-4 x 6	*	Ganel - Bulk - Vrac
M-4 x 7	*	Ganel - Bulk - Vrac
M-4 x 8	*	Ganel - Bulk - Vrac
M-4 x 10	*	Ganel - Bulk - Vrac
M-4 x 12	*	Ganel - Bulk - Vrac
M-4 x 15	*	Ganel - Bulk - Vrac
M-4 x 20	*	Ganel - Bulk - Vrac
M-4 x 25	*	Ganel - Bulk - Vrac
M-5 x 6	*	Ganel - Bulk - Vrac
M-5 x 8	*	Ganel - Bulk - Vrac
M-5 x 10	*	Ganel - Bulk - Vrac
M-5 x 12	*	Ganel - Bulk - Vrac
M-5 x 15	*	Ganel - Bulk - Vrac
M-5 x 20	*	Ganel - Bulk - Vrac
M-5 x 25	*	Ganel - Bulk - Vrac
M-6 x 10	*	Ganel - Bulk - Vrac
M-6 x 12	*	Ganel - Bulk - Vrac
M-6 x 15	*	Ganel - Bulk - Vrac
M-6 x 20	*	Ganel - Bulk - Vrac
M-6 x 25	*	Ganel - Bulk - Vrac

* Consultar disponibilidad. Tornillo de fabricación especial

* Inquire stock availability

* Consulter disponibilité



Especificaciones
en pág. 146

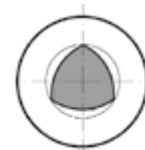

Corte transversal tornillo trilobular

Trilobular screw cross section
Section transversale de la vis trilobulaire



851/1TZ

Cruz philips
Punta atornillador
1/4" x 25



851/4TZ

Cruz philips
Punta atornillador
1/4" x 50

Ø Tornillo (mm)



M-3	PH-1
M-3,5 - M-5	PH-2
M-6	PH-3

Especificaciones en pág. 134

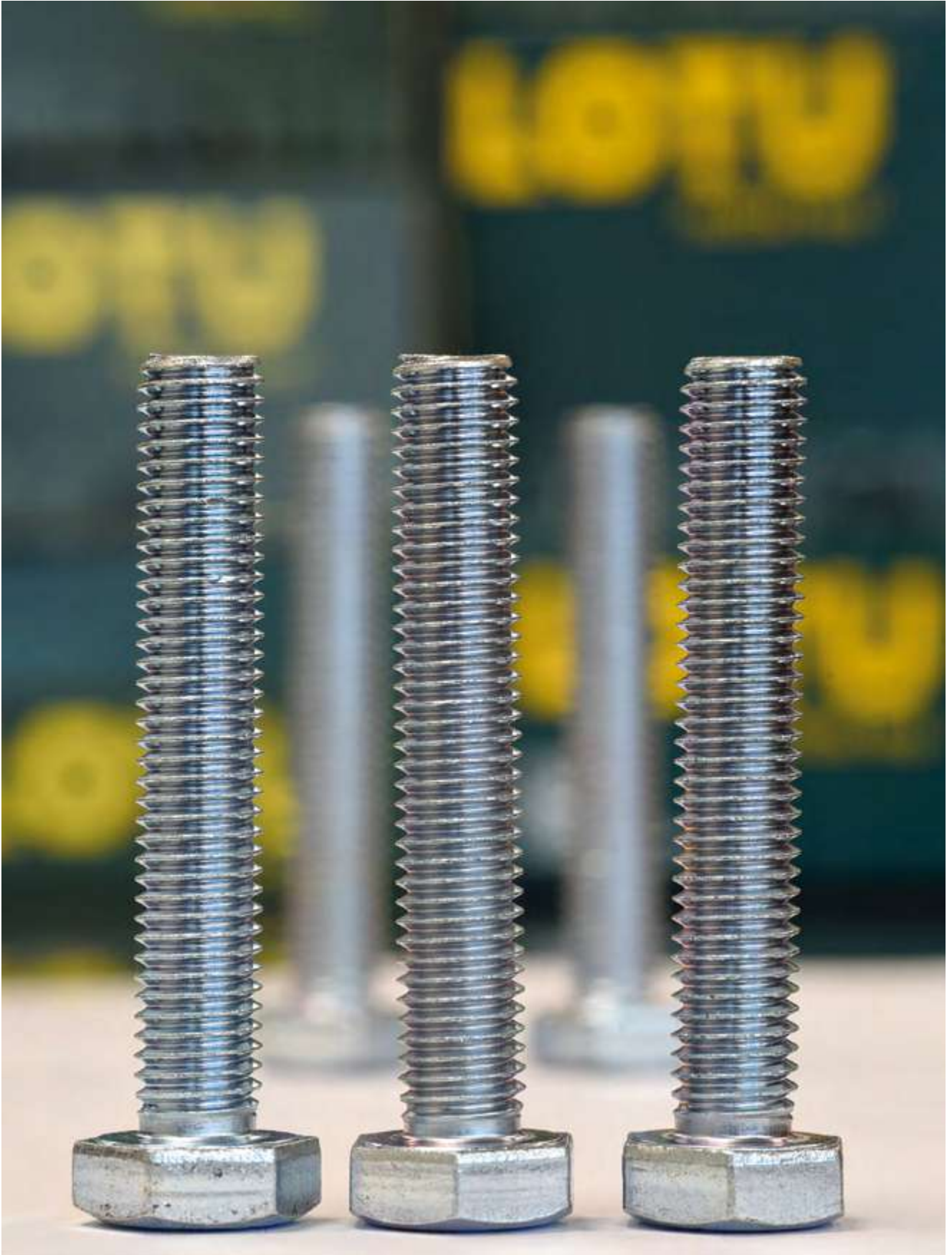

DIN 7500 M TX

Cabeza plana TX rosca trilobular autorroscante

TX countersunk head trilobular thread screw

Vis a métaux autotaraudeuse tête fraissée TX

Medida Size Dimension	Cincado Zinc plated Zingué	Embalaje Carton Emballage
mm.	€/1.000	
M-3 x 5	*	Ganel - Bulk - Vrac
M-3 x 6	*	Ganel - Bulk - Vrac
M-3 x 7	*	Ganel - Bulk - Vrac
M-3 x 8	*	Ganel - Bulk - Vrac
M-3 x 10	*	Ganel - Bulk - Vrac
M-3 x 12	*	Ganel - Bulk - Vrac
M-3 x 15	*	Ganel - Bulk - Vrac
M-3 x 20	*	Ganel - Bulk - Vrac
M-3,5 x 5	*	Ganel - Bulk - Vrac
M-3,5 x 6	*	Ganel - Bulk - Vrac
M-3,5 x 7	*	Ganel - Bulk - Vrac
M-3,5 x 8	*	Ganel - Bulk - Vrac
M-3,5 x 10	*	Ganel - Bulk - Vrac
M-3,5 x 12	*	Ganel - Bulk - Vrac
M-3,5 x 15	*	Ganel - Bulk - Vrac
M-3,5 x 20	*	Ganel - Bulk - Vrac
M-4 x 6	*	Ganel - Bulk - Vrac
M-4 x 7	*	Ganel - Bulk - Vrac
M-4 x 8	*	Ganel - Bulk - Vrac
M-4 x 10	*	Ganel - Bulk - Vrac
M-4 x 12	*	Ganel - Bulk - Vrac
M-4 x 15	*	Ganel - Bulk - Vrac
M-4 x 20	*	Ganel - Bulk - Vrac
M-4 x 25	*	Ganel - Bulk - Vrac
M-5 x 6	*	Ganel - Bulk - Vrac
M-5 x 8	*	Ganel - Bulk - Vrac
M-5 x 10	*	Ganel - Bulk - Vrac
M-5 x 12	*	Ganel - Bulk - Vrac
M-5 x 15	*	Ganel - Bulk - Vrac
M-5 x 20	*	Ganel - Bulk - Vrac
M-5 x 25	*	Ganel - Bulk - Vrac
M-6 x 10	*	Ganel - Bulk - Vrac
M-6 x 12	*	Ganel - Bulk - Vrac
M-6 x 15	*	Ganel - Bulk - Vrac
M-6 x 20	*	Ganel - Bulk - Vrac
M-6 x 25	*	Ganel - Bulk - Vrac

* Consultar disponibilidad. Tornillo de fabricación especial

* Inquire stock availability

* Consulter disponibilité



Especificaciones
en pág. 146

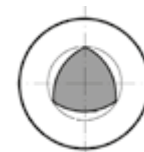

Corte transversal tornillo trilobular

Trilobular screw cross section
Section transversale de la vis trilobulaire



867/1TZ

Entalla TX
Punta atornillador
1/4" x 25



867/4TZ

Entalla TX
Punta atornillador
1/4" x 50

Ø Tornillo (mm)

M-3	TX-10
M-3,5	TX-15
M-4	TX-20
M-5	TX-25
M-6	TX-30

Especificaciones en pág. 134

LOTU[®]

The fixing brand



A photograph of a modern interior space, likely a lobby or hallway. The ceiling is composed of a grid of square, perforated metal panels. Several large, cylindrical columns support the structure. The lighting is recessed into the ceiling, creating a clean, industrial aesthetic. A white, angular graphic overlay is positioned in the upper right quadrant, containing text.

Rosca chapa

Self tapping screw
Vis a tôle



Especificaciones en pág. 146



Tapón
Cap / Bouchon



Colores disponibles
Colours / Couleurs

Especificaciones en pág. 128



851/1TZ
Cruz philips
Punta atornillador
1/4" x 25



851/4TZ
Cruz philips
Punta atornillador
1/4" x 50

Ø Tornillo (mm)	
2,20 - 2,90	PH-1
3,20 - 4,80	PH-2
5,50 - 6,30	PH-3

Especificaciones en pág. 134

DIN 7981

Cabeza alomada philips

Philips pan head self tapping screw

Vis a tôle tête cylindrique bombée large philips

Medida Size Dimension	Cincado Zinc plated Zingué	Cincado Negro Black Zinc plated Zingué Noir	Lacado Blanco White painted Laqué Blanc	Envasado Packing Emboîtage	Embalaje Carton Emballage
mm.	€/1.000	€/1.000	€/1.000	Und.	Und.
2,2 x 6,5	*	*		500	9.000
2,2 x 8,0	*	*		500	9.000
2,2 x 9,5	*	*		500	9.000
2,2 x 13	*	*		500	9.000
2,2 x 16	*	*		500	9.000
2,9 x 6,5	*	*		500	9.000
2,9 x 9,5	*	*		500	9.000
2,9 x 13	*	*		500	9.000
2,9 x 16	*	*		500	9.000
2,9 x 19	*	*		500	9.000
2,9 x 22	*	*		500	9.000
2,9 x 25	*	*		500	9.000
2,9 x 32	*	*		500	9.000
3,2 x 6,5	*	*		500	9.000
3,2 x 9,5	*	*		500	9.000
3,2 x 13	*	*		500	9.000
3,2 x 16	*	*		500	9.000
3,2 x 19	*	*		500	9.000
3,2 x 22	*	*		500	9.000
3,2 x 25	*	*		500	4.500
3,2 x 32	*	*		500	4.500
3,5 x 6,5	*	*	*	500	9.000
3,5 x 9,5	*	*	*	500	9.000
3,5 x 13	*	*	*	500	9.000
3,5 x 16	*	*	*	500	9.000
3,5 x 19	*	*	*	500	9.000
3,5 x 22	*	*	*	500	4.500
3,5 x 25	*	*	*	500	4.500
3,5 x 32	*	*	*	200	3.600
3,5 x 38	*	*	*	200	1.800
3,5 x 45	*	*	*	200	1.800
3,9 x 6,5	*	*	*	500	9.000
3,9 x 9,5	*	*	*	500	9.000
3,9 x 13	*	*	*	500	9.000
3,9 x 16	*	*	*	500	9.000
3,9 x 19	*	*	*	500	4.500
3,9 x 22	*	*	*	200	3.600
3,9 x 25	*	*	*	200	3.600
3,9 x 32	*	*	*	200	3.600
3,9 x 38	*	*	*	200	1.800
3,9 x 45	*	*	*	200	1.800
4,2 x 6,5	*	*	*	500	9.000
4,2 x 8,0	*	*	*	500	9.000
4,2 x 9,5	*	*	*	500	9.000
4,2 x 13	*	*	*	500	9.000
4,2 x 16	*	*	*	500	4.500
4,2 x 19	*	*	*	500	4.500
4,2 x 22	*	*	*	200	3.600
4,2 x 25	*	*	*	200	3.600
4,2 x 32	*	*	*	200	3.600

DIN 7981

Cabeza alomada philips

Philips pan head self tapping screw

Vis a tôle tête cylindrique bombée large philips

Medida Size Dimension	Cincado Zinc plated Zingué	Cincado Negro Black Zinc plated Zingué Noir	Lacado Blanco White painted Laqué Blanc	Envasado Packing Emboîtage	Embalaje Carton Emballage
mm.	€/1.000	€/1.000	€/1.000	Und.	Und.
4,2 x 38	*	*	*	200	1.800
4,2 x 45	*	*	*	200	1.800
4,2 x 50	*	*	*	200	1.200
4,2 x 60	*	*	*	200	1.200
4,2 x 70	*	*	*	200	1.200
4,2 x 80	*	*	*	200	1.200
4,8 x 9,5	*	*	*	200	3.600
4,8 x 13	*	*	*	200	3.600
4,8 x 16	*	*	*	200	3.600
4,8 x 19	*	*	*	200	3.600
4,8 x 22	*	*	*	200	3.600
4,8 x 25	*	*	*	200	1.800
4,8 x 32	*	*	*	200	1.800
4,8 x 38	*	*	*	200	1.800
4,8 x 45	*	*	*	200	1.200
4,8 x 50	*	*	*	200	1.200
4,8 x 60	*	*	*	100	600
4,8 x 70	*	*	*	100	900
4,8 x 80	*	*	*	100	900
4,8 x 90	*	*	*	100	900
4,8 x 100	*	*	*	100	900
4,8 x 120	*	*	*	100	600
4,8 x 140	*	*	*	100	600
4,8 x 160	*	*	*	100	600
5,5 x 9,5	*	*	*	200	3.600
5,5 x 13	*	*	*	200	3.600
5,5 x 16	*	*	*	200	3.600
5,5 x 19	*	*	*	200	3.600
5,5 x 22	*	*	*	200	1.800
5,5 x 25	*	*	*	200	1.800
5,5 x 32	*	*	*	200	1.800
5,5 x 38	*	*	*	200	1.200
5,5 x 45	*	*	*	200	1.200
5,5 x 50	*	*	*	100	900
5,5 x 60	*	*	*	100	600
5,5 x 70	*	*	*	100	600
5,5 x 80	*	*	*	100	600
5,5 x 90	*	*	*	100	600
5,5 x 100	*	*	*	100	600
5,5 x 120	*	*	*	100	600
6,3 x 13	*	*	*	200	1.800
6,3 x 16	*	*	*	200	1.800
6,3 x 19	*	*	*	200	1.800
6,3 x 22	*	*	*	200	1.800
6,3 x 25	*	*	*	200	1.800
6,3 x 32	*	*	*	200	1.200
6,3 x 38	*	*	*	200	1.200
6,3 x 45	*	*	*	100	900
6,3 x 50	*	*	*	100	600
6,3 x 60	*	*	*	100	600
6,3 x 70	*	*	*	100	600



Especificaciones
en pág. 146



Tapón
Cap / Bouchon



Colores disponibles
Colours / Couleurs

Especificaciones
en pág. 128



851/1TZ
Cruz philips
Punta atornillador
1/4" x 25



851/4TZ
Cruz philips
Punta atornillador
1/4" x 50

Ø Tornillo (mm)

2,20 - 2,90 PH-1
3,20 - 4,80 PH-2
5,50 - 6,30 PH-3

Especificaciones en pág. 134



Especificaciones en pág. 146



Tapón
Cap / Bouchon



Colores disponibles
Colours / Couleurs

Especificaciones en pág. 128



851/1TZ
Cruz philips
Punta atornillador
1/4" x 25



851/4TZ
Cruz philips
Punta atornillador
1/4" x 50

Ø Tornillo (mm)

2,20 - 2,90	PH-1
3,20 - 4,80	PH-2
5,50 - 6,30	PH-3

Especificaciones en pág. 134

*** Consultar disponibilidad.
Tornillo de fabricacion especial**

* Inquire stock availability

* Consulter disponibilité

DIN 7981 F

Cabeza alomada philips punta F

Philips pan head self tapping screw point type F

Vis a tôle tête cylindrique bombée large philips bout plat

Medida Size Dimension	Cincado Zinc plated Zingué	Embalaje Carton Emballage
mm.	€/1.000	
2,2 x 5,0	*	Ganel - Bulk - Vrac
2,2 x 6,5	*	Ganel - Bulk - Vrac
2,2 x 9,5	*	Ganel - Bulk - Vrac
2,2 x 13	*	Ganel - Bulk - Vrac
2,2 x 16	*	Ganel - Bulk - Vrac
2,9 x 6,5	*	Ganel - Bulk - Vrac
2,9 x 9,5	*	Ganel - Bulk - Vrac
2,9 x 13	*	Ganel - Bulk - Vrac
2,9 x 16	*	Ganel - Bulk - Vrac
2,9 x 19	*	Ganel - Bulk - Vrac
2,9 x 22	*	Ganel - Bulk - Vrac
2,9 x 25	*	Ganel - Bulk - Vrac
2,9 x 32	*	Ganel - Bulk - Vrac
3,2 x 6,5	*	Ganel - Bulk - Vrac
3,2 x 9,5	*	Ganel - Bulk - Vrac
3,2 x 13	*	Ganel - Bulk - Vrac
3,2 x 16	*	Ganel - Bulk - Vrac
3,2 x 19	*	Ganel - Bulk - Vrac
3,2 x 22	*	Ganel - Bulk - Vrac
3,2 x 25	*	Ganel - Bulk - Vrac
3,5 x 6,5	*	Ganel - Bulk - Vrac
3,5 x 9,5	*	Ganel - Bulk - Vrac
3,5 x 13	*	Ganel - Bulk - Vrac
3,5 x 16	*	Ganel - Bulk - Vrac
3,5 x 19	*	Ganel - Bulk - Vrac
3,5 x 22	*	Ganel - Bulk - Vrac
3,5 x 25	*	Ganel - Bulk - Vrac
3,9 x 6,5	*	Ganel - Bulk - Vrac
3,9 x 9,5	*	Ganel - Bulk - Vrac
3,9 x 13	*	Ganel - Bulk - Vrac
3,9 x 16	*	Ganel - Bulk - Vrac
3,9 x 19	*	Ganel - Bulk - Vrac
3,9 x 22	*	Ganel - Bulk - Vrac
3,9 x 25	*	Ganel - Bulk - Vrac
4,2 x 6,5	*	Ganel - Bulk - Vrac
4,2 x 9,5	*	Ganel - Bulk - Vrac
4,2 x 13	*	Ganel - Bulk - Vrac
4,2 x 16	*	Ganel - Bulk - Vrac
4,2 x 19	*	Ganel - Bulk - Vrac
4,2 x 22	*	Ganel - Bulk - Vrac
4,2 x 25	*	Ganel - Bulk - Vrac
4,8 x 9,5	*	Ganel - Bulk - Vrac
4,8 x 13	*	Ganel - Bulk - Vrac
4,8 x 16	*	Ganel - Bulk - Vrac
4,8 x 19	*	Ganel - Bulk - Vrac
4,8 x 22	*	Ganel - Bulk - Vrac
4,8 x 25	*	Ganel - Bulk - Vrac
5,5 x 9,5	*	Ganel - Bulk - Vrac
5,5 x 13	*	Ganel - Bulk - Vrac
5,5 x 16	*	Ganel - Bulk - Vrac
5,5 x 19	*	Ganel - Bulk - Vrac
5,5 x 22	*	Ganel - Bulk - Vrac
5,5 x 25	*	Ganel - Bulk - Vrac

DIN 7981 G

Cabeza alomada philips punta guía

Philips pan head self tapping screw lead point

Vis a tôle tête cylindrique bombée large philips bout guide

Medida Size Dimension	Cincado Zinc plated Zingué	Embalaje Carton Emballage
mm.	€/1.000	
4,2 x 19	*	Granel - Bulk - Vrac
4,2 x 22	*	Granel - Bulk - Vrac
4,2 x 25	*	Granel - Bulk - Vrac
4,2 x 32	*	Granel - Bulk - Vrac
4,2 x 38	*	Granel - Bulk - Vrac
4,8 x 19	*	Granel - Bulk - Vrac
4,8 x 22	*	Granel - Bulk - Vrac
4,8 x 25	*	Granel - Bulk - Vrac
4,8 x 32	*	Granel - Bulk - Vrac
4,8 x 38	*	Granel - Bulk - Vrac
5,5 x 19	*	Granel - Bulk - Vrac
5,5 x 22	*	Granel - Bulk - Vrac
5,5 x 25	*	Granel - Bulk - Vrac
5,5 x 32	*	Granel - Bulk - Vrac
5,5 x 38	*	Granel - Bulk - Vrac

*** Consultar disponibilidad. Tornillo de fabricacion especial**

* Inquire stock availability

* Consulter disponibilité

11C-91

Cabeza alomada philips arandela estampada punta C

philips pan head self tapping screw with washer

Vis a tôle tête cylindrique bombée large philips avec rondelle

Medida Size Dimension	Cincado Zinc plated Zingué	Cincado Negro Black Zinc plated Zingué Noir	Envasado Packing Emboîtage	Embalaje Carton Emballage
mm.	€/1.000	€/1.000	Und.	Und.
3,9 x 9,5	*	*	500	9.000
3,9 x 13	*	*	500	9.000
3,9 x 16	*	*	500	9.000
4,2 x 9,5	*	*	500	9.000
4,2 x 13	*	*	500	9.000
4,2 x 16	*	*	500	4.500
4,2 x 19	*	*	500	4.500
4,2 x 25	*	*	200	3.600
4,2 x 32	*	*	200	3.600
4,8 x 13	*	*	200	3.600
4,8 x 16	*	*	200	3.600
4,8 x 19	*	*	200	3.600
4,8 x 22	*	*	200	3.600
4,8 x 25	*	*	200	1.800
4,8 x 32	*	*	200	1.800
4,8 x 38	*	*	200	1.800



Especificaciones en pág. 146



851/1TZ

Cruz philips
Punta atornillador
1/4" x 25



851/4TZ

Cruz philips
Punta atornillador
1/4" x 50

Ø Tornillo (mm)



2,20 - 2,90 PH-1

3,20 - 4,80 PH-2

5,50 - 6,30 PH-3

Especificaciones en pág. 134





Especificaciones en pág. 146



Tapón
Cap / Bouchon



Colores disponibles
Colours / Couleurs

Especificaciones en pág. 128



867/1TZ 
Entalla TX
Punta atornillador
1/4" x 25



867/4TZ 
Entalla TX
Punta atornillador
1/4" x 50

Ø Tornillo (mm) 

2,90	TX-10
3,50	TX-15
3,90 - 4,20	TX-20
4,80 - 6,30	TX-25

Especificaciones en pág. 134

*** Consultar disponibilidad.
Tornillo de fabricación especial**

* Inquire stock availability

* Consulter disponibilité

DIN 7981 TX

Cabeza alomada TX

TX pan head self tapping screw

Vis a tôle tête cylindrique bombée large empreinte TX

Medida Size Dimension	Cincado Zinc plated Zingué	Cincado Negro Black Zinc plated Zingué Noir	Inoxidable Stainless steel A2	Envasado Packing Emboîtage	Embalaje Carton Emballage
mm.	€/1.000	€/1.000	€/1.000	Und.	Und.
2,9 x 9,5	*	*	*	500	9.000
2,9 x 13	*	*	*	500	9.000
2,9 x 16	*	*	*	500	9.000
3,5 x 9,5	*	*	*	500	9.000
3,5 x 13	*	*	*	500	9.000
3,5 x 16	*	*	*	500	9.000
3,5 x 19	*	*	*	500	9.000
3,5 x 22	*	*	*	500	4.500
3,5 x 25	*	*	*	500	4.500
3,9 x 9,5	*	*	*	500	9.000
3,9 x 13	*	*	*	500	9.000
3,9 x 16	*	*	*	500	9.000
3,9 x 19	*	*	*	500	4.500
3,9 x 22	*	*	*	200	3.600
3,9 x 25	*	*	*	200	3.600
4,2 x 9,5	*	*	*	500	9.000
4,2 x 13	*	*	*	500	9.000
4,2 x 16	*	*	*	500	4.500
4,2 x 19	*	*	*	500	4.500
4,2 x 22	*	*	*	200	3.600
4,2 x 25	*	*	*	200	3.600
4,2 x 32	*	*	*	200	3.600
4,2 x 38	*	*	*	200	1.800
4,2 x 45	*	*	*	200	1.800
4,2 x 50	*	*	*	200	1.200
4,8 x 9,5	*	*	*	200	3.600
4,8 x 13	*	*	*	200	3.600
4,8 x 16	*	*	*	200	3.600
4,8 x 19	*	*	*	200	3.600
4,8 x 22	*	*	*	200	3.600
4,8 x 25	*	*	*	200	1.800
4,8 x 32	*	*	*	200	1.800
4,8 x 38	*	*	*	200	1.800
4,8 x 45	*	*	*	200	1.200
4,8 x 50	*	*	*	200	1.200
4,8 x 60	*	*	*	100	600
4,8 x 70	*	*	*	100	900
5,5 x 9,5	*	*	*	200	3.600
5,5 x 13	*	*	*	200	3.600
5,5 x 16	*	*	*	200	3.600
5,5 x 19	*	*	*	200	3.600
5,5 x 22	*	*	*	200	1.800
5,5 x 25	*	*	*	200	1.800
5,5 x 32	*	*	*	200	1.800
5,5 x 38	*	*	*	200	1.200
5,5 x 45	*	*	*	200	1.200
5,5 x 50	*	*	*	100	900
5,5 x 60	*	*	*	100	600
5,5 x 70	*	*	*	100	600

DIN 7982 TX

Cabeza plana TX

TX countersunk head self tapping screw

Vis a tôle tête fraisée empreinte TX

Medida Size Dimension	Cincado Zinc plated Zingué	Embalaje Carton Emballage
mm.	€/1.000	
3,5x9,5	*	Ganel - Bulk - Vrac
3,5x13	*	Ganel - Bulk - Vrac
3,5x16	*	Ganel - Bulk - Vrac
3,5x19	*	Ganel - Bulk - Vrac
3,5x22	*	Ganel - Bulk - Vrac
3,5x25	*	Ganel - Bulk - Vrac
3,9x9,5	*	Ganel - Bulk - Vrac
3,9x13	*	Ganel - Bulk - Vrac
3,9x16	*	Ganel - Bulk - Vrac
3,9x19	*	Ganel - Bulk - Vrac
3,9x22	*	Ganel - Bulk - Vrac
3,9x25	*	Ganel - Bulk - Vrac
4,2x9,5	*	Ganel - Bulk - Vrac
4,2x13	*	Ganel - Bulk - Vrac
4,2x16	*	Ganel - Bulk - Vrac
4,2x19	*	Ganel - Bulk - Vrac
4,2x22	*	Ganel - Bulk - Vrac
4,2x25	*	Ganel - Bulk - Vrac
4,2x32	*	Ganel - Bulk - Vrac
4,2x38	*	Ganel - Bulk - Vrac
4,8x13	*	Ganel - Bulk - Vrac
4,8x16	*	Ganel - Bulk - Vrac
4,8x19	*	Ganel - Bulk - Vrac
4,8x22	*	Ganel - Bulk - Vrac
4,8x25	*	Ganel - Bulk - Vrac
4,8x32	*	Ganel - Bulk - Vrac
4,8x38	*	Ganel - Bulk - Vrac
4,8x45	*	Ganel - Bulk - Vrac
4,8x50	*	Ganel - Bulk - Vrac
4,8x60	*	Ganel - Bulk - Vrac
4,8x70	*	Ganel - Bulk - Vrac
5,5x16	*	Ganel - Bulk - Vrac
5,5x19	*	Ganel - Bulk - Vrac
5,5x22	*	Ganel - Bulk - Vrac
5,5x25	*	Ganel - Bulk - Vrac
5,5x32	*	Ganel - Bulk - Vrac
5,5x38	*	Ganel - Bulk - Vrac
5,5x45	*	Ganel - Bulk - Vrac
5,5x50	*	Ganel - Bulk - Vrac
5,5x60	*	Ganel - Bulk - Vrac
5,5x70	*	Ganel - Bulk - Vrac

* Consultar disponibilidad. Tornillo de fabricacion especial

* Inquire stock availability

* Consulter disponibilité



Especificaciones
en pág. 146



867/1TZ 
Entalla TX
Punta atornillador
1/4" x 25



867/4TZ 
Entalla TX
Punta atornillador
1/4" x 50

Ø Tornillo (mm)	
2,90	TX-10
3,50	TX-15
3,90 - 4,20	TX-20
4,80 - 6,30	TX-25

Especificaciones en pág. 134



Especificaciones en pág. 146



851/1TZ
Cruz philips
Punta atornillador
1/4" x 25



851/4TZ
Cruz philips
Punta atornillador
1/4" x 50

Ø Tornillo (mm) 

2,20 - 2,90	PH-1
3,20 - 4,80	PH-2
5,50 - 6,30	PH-3

Especificaciones en pág. 134

DIN 7982

Cabeza plana philips

Philips countersunk head self tapping screw

Vis a tôle tête fraisée philips

Medida Size Dimension	Cincado Zinc plated Zingué	Cincado Negro Black Zinc plated Zingué Noir	Inoxidable Stainless Ino x ydable	Envasado Packing Emboîtage	Embalaje Carton Emballage
mm.	€/1.000	€/1.000	€/1.000	Und.	Und.
2,2 x 6,5	*	*	*	500	9.000
2,2 x 9,5	*	*	*	500	9.000
2,2 x 13	*	*	*	500	9.000
2,2 x 16	*	*	*	500	9.000
2,9 x 6,5	*	*	*	500	9.000
2,9 x 9,5	*	*	*	500	9.000
2,9 x 13	*	*	*	500	9.000
2,9 x 16	*	*	*	500	9.000
2,9 x 19	*	*	*	500	9.000
2,9 x 22	*	*	*	500	9.000
2,9 x 25	*	*	*	500	9.000
2,9 x 32	*	*	*	500	9.000
3,2 x 6,5	*	*	*	500	9.000
3,2 x 9,5	*	*	*	500	9.000
3,2 x 13	*	*	*	500	9.000
3,2 x 16	*	*	*	500	9.000
3,2 x 19	*	*	*	500	9.000
3,2 x 22	*	*	*	500	9.000
3,2 x 25	*	*	*	500	4.500
3,2 x 32	*	*	*	500	4.500
3,5 x 6,5	*	*	*	500	9.000
3,5 x 9,5	*	*	*	500	9.000
3,5 x 13	*	*	*	500	9.000
3,5 x 16	*	*	*	500	9.000
3,5 x 19	*	*	*	500	9.000
3,5 x 22	*	*	*	500	4.500
3,5 x 25	*	*	*	500	4.500
3,5 x 32	*	*	*	200	3.600
3,5 x 38	*	*	*	200	1.800
3,5 x 45	*	*	*	200	1.800
3,9 x 9,5	*	*	*	500	9.000
3,9 x 13	*	*	*	500	9.000
3,9 x 16	*	*	*	500	9.000
3,9 x 19	*	*	*	500	4.500
3,9 x 22	*	*	*	200	3.600
3,9 x 25	*	*	*	200	3.600
3,9 x 32	*	*	*	200	3.600
3,9 x 38	*	*	*	200	1.800
3,9 x 45	*	*	*	200	1.800
4,2 x 9,5	*	*	*	500	9.000
4,2 x 13	*	*	*	500	9.000
4,2 x 16	*	*	*	500	4.500
4,2 x 19	*	*	*	500	4.500

DIN 7982

Cabeza plana philips

Philips countersunk head self tapping screw

Vis a tôle tête fraisée philips

Medida Size Dimension	Cincado Zinc plated Zingué	Cincado Negro Black Zinc plated Zingué Noir	Inoxidable Stainless Inoxydable	Envasado Packing Emboîtage	Embalaje Carton Emballage
mm.	€/1.000	€/1.000	€/1.000	Und.	Und.
4,2 x 22	*	*	*	200	3.600
4,2 x 25	*	*	*	200	3.600
4,2 x 32	*	*	*	200	3.600
4,2 x 38	*	*	*	200	1.800
4,2 x 45	*	*	*	200	1.800
4,2 x 50	*	*	*	200	1.200
4,2 x 60	*	*	*	200	1.200
4,2 x 70	*	*	*	200	1.200
4,8 x 9,5	*	*	*	200	3.600
4,8 x 13	*	*	*	200	3.600
4,8 x 16	*	*	*	200	3.600
4,8 x 19	*	*	*	200	3.600
4,8 x 22	*	*	*	200	3.600
4,8 x 25	*	*	*	200	1.800
4,8 x 32	*	*	*	200	1.800
4,8 x 38	*	*	*	200	1.800
4,8 x 45	*	*	*	200	1.200
4,8 x 50	*	*	*	200	1.200
4,8 x 60	*	*	*	100	600
4,8 x 70	*	*	*	100	900
5,5 x 13	*	*	*	200	3.600
5,5 x 16	*	*	*	200	3.600
5,5 x 19	*	*	*	200	3.600
5,5 x 22	*	*	*	200	1.800
5,5 x 25	*	*	*	200	1.800
5,5 x 32	*	*	*	200	1.800
5,5 x 38	*	*	*	200	1.200
5,5 x 45	*	*	*	200	1.200
5,5 x 50	*	*	*	100	900
5,5 x 60	*	*	*	100	600
5,5 x 70	*	*	*	100	600
6,3 x 13	*	*	*	200	1.800
6,3 x 16	*	*	*	200	1.800
6,3 x 19	*	*	*	200	1.800
6,3 x 22	*	*	*	200	1.800
6,3 x 25	*	*	*	200	1.800
6,3 x 32	*	*	*	200	1.200
6,3 x 38	*	*	*	200	1.200
6,3 x 45	*	*	*	100	900
6,3 x 50	*	*	*	100	600
6,3 x 60	*	*	*	100	600
6,3 x 70	*	*	*	100	600



Especificaciones
en pág. 146



851/1TZ
Cruz philips
Punta atornillador
1/4" x 25



851/4TZ
Cruz philips
Punta atornillador
1/4" x 50

Ø Tornillo (mm)



2,20 - 2,90	PH-1
3,20 - 4,80	PH-2
5,50 - 6,30	PH-3

Especificaciones en pág. 134

*** Consultar disponibilidad. Tornillo de fabricación especial**

* Inquire stock availability

* Consulter disponibilité



Especificaciones en pág. 146



851/1TZ
Cruz philips
Punta atornillador
1/4" x 25



851/4TZ
Cruz philips
Punta atornillador
1/4" x 50

Ø Tornillo (mm)	
2,20 - 2,90	PH-1
3,20 - 4,80	PH-2
5,50 - 6,30	PH-3

Especificaciones en pág. 134

DIN 7983

Gota sebo philips

Philips raised countersunk head self tapping screw

Vis a tôle tête fraisée bombée philips

Medida Size Dimension	Cincado Zinc plated Zingué	Cincado Negro Black Zinc plated Zingué Noir	Envasado Packing Emboîtage	Embalaje Carton Emballage
mm.	€/1.000	€/1.000	Und.	Und.
2,2 x 6,5	*	*	500	9.000
2,2 x 9,5	*	*	500	9.000
2,2 x 13	*	*	500	9.000
2,2 x 16	*	*	500	9.000
2,9 x 6,5	*	*	500	9.000
2,9 x 9,5	*	*	500	9.000
2,9 x 13	*	*	500	9.000
2,9 x 16	*	*	500	9.000
2,9 x 19	*	*	500	9.000
2,9 x 22	*	*	500	9.000
2,9 x 25	*	*	500	9.000
2,9 x 32	*	*	500	9.000
3,2 x 6,5	*	*	500	9.000
3,2 x 9,5	*	*	500	9.000
3,2 x 13	*	*	500	9.000
3,2 x 16	*	*	500	9.000
3,2 x 19	*	*	500	9.000
3,2 x 22	*	*	500	9.000
3,2 x 25	*	*	500	4.500
3,2 x 32	*	*	500	4.500
3,5 x 6,5	*	*	500	9.000
3,5 x 9,5	*	*	500	9.000
3,5 x 13	*	*	500	9.000
3,5 x 16	*	*	500	9.000
3,5 x 19	*	*	500	9.000
3,5 x 22	*	*	500	4.500
3,5 x 25	*	*	500	4.500
3,5 x 32	*	*	200	3.600
3,5 x 38	*	*	200	1.800
3,5 x 45	*	*	200	1.800
3,9 x 9,5	*	*	500	9.000
3,9 x 13	*	*	500	9.000
3,9 x 16	*	*	500	9.000
3,9 x 19	*	*	500	4.500
3,9 x 22	*	*	200	3.600
3,9 x 25	*	*	200	3.600
3,9 x 32	*	*	200	3.600
3,9 x 38	*	*	200	1.800
3,9 x 45	*	*	200	1.800
4,2 x 9,5	*	*	500	9.000
4,2 x 13	*	*	500	9.000
4,2 x 16	*	*	500	4.500
4,2 x 19	*	*	500	4.500
4,2 x 22	*	*	200	3.600
4,2 x 25	*	*	200	3.600

DIN 7983

Gota sebo philips

Philips raised countersunk head self tapping screw

Vis a tôle tête fraisée bombée philips

Medida Size Dimension	Cincado Zinc plated Zingué	Cincado Negro Black Zinc plated Zingué Noir	Envasado Packing Emboîtage	Embalaje Carton Emballage
mm.	€/1.000	€/1.000	Und.	Und.
4,2 x 32	*	*	200	3.600
4,2 x 38	*	*	200	1.800
4,2 x 45	*	*	200	1.800
4,2 x 50	*	*	200	1.200
4,2 x 60	*	*	200	1.200
4,2 x 70	*	*	200	1.200
4,8 x 9,5	*	*	200	3.600
4,8 x 13	*	*	200	3.600
4,8 x 16	*	*	200	3.600
4,8 x 19	*	*	200	3.600
4,8 x 22	*	*	200	3.600
4,8 x 25	*	*	200	1.800
4,8 x 32	*	*	200	1.800
4,8 x 38	*	*	200	1.800
4,8 x 45	*	*	200	1.200
4,8 x 50	*	*	200	1.200
4,8 x 60	*	*	100	600
4,8 x 70	*	*	100	900
5,5 x 13	*	*	200	3.600
5,5 x 16	*	*	200	3.600
5,5 x 19	*	*	200	3.600
5,5 x 22	*	*	200	1.800
5,5 x 25	*	*	200	1.800
5,5 x 32	*	*	200	1.800
5,5 x 38	*	*	200	1.200
5,5 x 45	*	*	200	1.200
5,5 x 50	*	*	100	900
5,5 x 60	*	*	100	600
5,5 x 70	*	*	100	600
6,3 x 13	*	*	200	1.800
6,3 x 16	*	*	200	1.800
6,3 x 19	*	*	200	1.800
6,3 x 22	*	*	200	1.800
6,3 x 25	*	*	200	1.800
6,3 x 32	*	*	200	1.200
6,3 x 38	*	*	200	1.200
6,3 x 45	*	*	100	900
6,3 x 50	*	*	100	600
6,3 x 60	*	*	100	600
6,3 x 70	*	*	100	600



Especificaciones en pág. 146



851/1TZ

Cruz philips
Punta atornillador
1/4" x 25



851/4TZ

Cruz philips
Punta atornillador
1/4" x 50

Ø Tornillo (mm)



2,20 - 2,90	PH-1
3,20 - 4,80	PH-2
5,50 - 6,30	PH-3

Especificaciones en pág. 134



Especificaciones en pág. 146



800/1TZ
Ranura longitudinal
Punta atornillador
1/4" x 25

Ø Tornillo (mm)



2,20	0,6x4,5
2,90 - 3,20	0,8x5,5
3,50 - 3,90	1,0x5,5
4,20 - 4,80	1,2x6,5
5,50 - 6,30	1,6x8,0

Especificaciones en pág. 134

DIN 7971

Ancha ranura

Slotted pan head self tapping screw

Vis a tôle tête cylindrique fendue

Medida Size Dimension	Cincado Zinc plated Zingué	Envasado Packing Emboitage	Embalaje Carton Emballage
mm.	€/1.000	Und.	Und.
2,2 x 6,5	*	500	9.000
2,2 x 13	*	500	9.000
2,9 x 6,5	*	500	9.000
2,9 x 9,5	*	500	9.000
2,9 x 13	*	500	9.000
2,9 x 19	*	500	9.000
2,9 x 22	*	500	9.000
2,9 x 25	*	500	9.000
2,9 x 32	*	500	9.000
3,2 x 6,5	*	500	9.000
3,2 x 9,5	*	500	9.000
3,2 x 13	*	500	9.000
3,2 x 16	*	500	9.000
3,2 x 19	*	500	9.000
3,2 x 22	*	500	9.000
3,2 x 25	*	500	4.500
3,2 x 32	*	500	4.500
3,5 x 9,5	*	500	9.000
3,5 x 13	*	500	9.000
3,5 x 16	*	500	9.000
3,5 x 19	*	500	9.000
3,5 x 22	*	500	4.500
3,5 x 25	*	500	4.500
3,5 x 38	*	200	1.800
3,9 x 6,5	*	500	9.000
3,9 x 9,5	*	500	9.000
3,9 x 13	*	500	9.000
3,9 x 16	*	500	9.000
3,9 x 19	*	500	4.500
3,9 x 22	*	200	3.600
3,9 x 25	*	200	3.600
3,9 x 32	*	200	3.600
3,9 x 38	*	200	1.800
4,2 x 6,5	*	500	9.000
4,2 x 13	*	500	9.000
4,2 x 16	*	500	4.500
4,2 x 19	*	500	4.500
4,2 x 38	*	200	1.800
4,2 x 60	*	200	1.200
4,8 x 13	*	200	3.600
4,8 x 19	*	200	3.600
4,8 x 22	*	200	3.600
4,8 x 25	*	200	1.800
4,8 x 32	*	200	1.800
4,8 x 38	*	200	1.800
4,8 x 50	*	200	1.200

DIN 7971

Ancha ranura

Slotted pan head self tapping screw

Vis a tôle tête cylindrique fendue

Medida Size Dimension	Cincado Zinc plated Zingué	Envasado Packing Emboitage	Embalaje Carton Emballage
mm.	€/1.000	Und.	Und.
5,5 x 13	*	200	3.600
5,5 x 19	*	200	3.600
5,5 x 38	*	200	1.200
5,5 x 45	*	200	1.200
5,5 x 50	*	100	900
5,5 x 60	*	100	600
5,5 x 70	*	100	600
6,3 x 19	*	200	1.800
6,3 x 25	*	200	1.800
6,3 x 32	*	200	1.200
6,3 x 38	*	200	1.200
6,3 x 45	*	100	900
6,3 x 60	*	100	600



Especificaciones
en pág. 146



800/1TZ

Ranura longitudinal
Punta atornillador
1/4" x 25

Ø Tornillo (mm)



2,20	0,6x4,5
2,90 - 3,20	0,8x5,5
3,50 - 3,90	1,0x5,5
4,20 - 4,80	1,2x6,5
5,50 - 6,30	1,6x8,0

Especificaciones en pág. 134



LOTU[®]

The fixing brand



Autotaladrante

Self drilling screw

Vis a tôle autoperceuse



Especificaciones en pág. 146



Tapón
Cap / Bouchon



Colores disponibles
Colours / Couleurs

Especificaciones en pág. 128



851/1TZ
Cruz philips
Punta atornillador
1/4" x 25



851/4TZ
Cruz philips
Punta atornillador
1/4" x 50

Ø Tornillo (mm)	
3,50 - 4,80	PH-2
5,50	PH-3

Especificaciones en pág. 134

DIN 7504-N

Cabeza alomada philips rosca chapa autotaladrante

Philips pan head self drilling screw

Vis a tôle autoperceuse tête cylindrique bombée philips

Medida Size Dimension	Cincado Zinc plated Zingué	Cincado Negro Black Zinc plated Zingué Noir	Lacado Blanco White painted Laqué Blanc	Envasado Packing Emboîtage	Embalaje Carton Emballage
mm.	€/1.000	€/1.000	€/1.000	Und.	Und.
3,5 x 9,5	*	*	*	500	9.000
3,5 x 13	*	*	*	500	9.000
3,5 x 16	*	*	*	500	9.000
3,5 x 19	*	*	*	500	9.000
3,5 x 22	*	*	*	500	4.500
3,5 x 25	*	*	*	500	4.500
3,5 x 32	*	*	*	200	3.600
3,9 x 13	*	*	*	500	9.000
3,9 x 16	*	*	*	500	9.000
3,9 x 19	*	*	*	500	4.500
3,9 x 22	*	*	*	200	3.600
3,9 x 25	*	*	*	200	3.600
3,9 x 32	*	*	*	200	3.600
3,9 x 38	*	*	*	200	1.800
4,2 x 13	*	*	*	500	9.000
4,2 x 16	*	*	*	500	4.500
4,2 x 19	*	*	*	500	4.500
4,2 x 22	*	*	*	200	3.600
4,2 x 25	*	*	*	200	3.600
4,2 x 32	*	*	*	200	3.600
4,2 x 38	*	*	*	200	1.800
4,2 x 50	*	*	*	200	1.200
4,8 x 13	*	*	*	200	3.600
4,8 x 16	*	*	*	200	3.600
4,8 x 19	*	*	*	200	3.600
4,8 x 22	*	*	*	200	3.600
4,8 x 25	*	*	*	200	1.800
4,8 x 32	*	*	*	200	1.800
4,8 x 38	*	*	*	200	1.800
4,8 x 45	*	*	*	200	1.200
4,8 x 50	*	*	*	200	1.200
4,8 x 60	*	*	*	100	600
4,8 x 70	*	*	*	100	900
4,8 x 80	*	*	*	100	900
4,8 x 90	*	*	*	100	900
4,8 x 100	*	*	*	100	900
4,8 x 110	*	*	*	100	900
4,8 x 120	*	*	*	100	600
5,5 x 19	*	*	*	200	3.600
5,5 x 22	*	*	*	200	1.800
5,5 x 25	*	*	*	200	1.800
5,5 x 32	*	*	*	200	1.800
5,5 x 38	*	*	*	200	1.200
5,5 x 45	*	*	*	200	1.200
5,5 x 50	*	*	*	100	900
5,5 x 60	*	*	*	100	600
5,5 x 70	*	*	*	100	600

DIN 7504-N TX

Cabeza alomada TX rosca chapa autotaladrante

TX pan head self drilling screw

Vis à tôle autoperceuse tête cylindrique bombée TX

Medida Size Dimension	Cincado Zinc plated Zingué	Cincado Negro Black Zinc plated Zingué Noir	Envasado Packing Emboîtage	Embalaje Carton Emballage
mm.	€/1.000	€/1.000	Und.	Und.
3,5 x 9,5	*	*	500	9.000
3,5 x 13	*	*	500	9.000
3,5 x 16	*	*	500	9.000
3,5 x 19	*	*	500	9.000
4,2 x 13	*	*	500	9.000
4,2 x 16	*	*	500	4.500
4,2 x 19	*	*	500	4.500
4,2 x 25	*	*	200	3.600
4,8 x 16	*	*	200	3.600
4,8 x 19	*	*	200	3.600
4,8 x 25	*	*	200	1.800
4,8 x 32	*	*	200	1.800
4,8 x 38	*	*	200	1.800
4,8 x 45	*	*	200	1.200
4,8 x 50	*	*	200	1.200
4,8 x 60	*	*	100	600
4,8 x 70	*	*	100	900



Especificaciones en pág. 146

16B-91

Cabeza alomada philips con arandela autotaladrante

Philips wafer head self drilling screw

Tête cylindrique avec embase philips autoperceuse

Medida Size Dimension	Cincado Zinc plated Zingué	Cincado Negro Black Zinc plated Zingué Noir	Envasado Packing Emboîtage	Embalaje Carton Emballage
mm.	€/1.000	€/1.000	Und.	Und.
4,2 x 13	*	*	500	9.000
4,2 x 16	*	*	500	4.500
4,2 x 19	*	*	500	4.500
4,2 x 25	*	*	200	3.600
4,2 x 32	*	*	200	3.600
4,2 x 38	*	*	200	1.800



Especificaciones en pág. 146



851/1TZ
Cruz philips
Punta atornillador
1/4" x 25



851/4TZ
Cruz philips
Punta atornillador
1/4" x 50

Ø Tornillo (mm)



3,50 - 4,80

PH-2

Especificaciones en pág. 134



Especificaciones en pág. 146



Tapón
Cap / Bouchon



Colores disponibles
Colours / Couleurs

Especificaciones en pág. 128



851/1TZ
Cruz philips
Punta atornillador
1/4" x 25



851/4TZ
Cruz philips
Punta atornillador
1/4" x 50

Ø Tornillo (mm)



3,50 - 4,80	PH-2
5,50	PH-3

Especificaciones en pág. 134

DIN 7504-P

Cabeza plana philips rosca chapa autotaladrante

Philips countersunk head self drilling screw

Vis a tôle autoperceuse tête fraisée philips

Medida Size Dimension	Cincado Zinc plated Zingué	Cincado Negro Black Zinc plated Zingué Noir	Envasado Packing Emboîtage	Embalaje Carton Emballage
mm.	€/1.000	€/1.000	Und.	Und.
3,5 x 9,5	*	*	500	9.000
3,5 x 13	*	*	500	9.000
3,5 x 16	*	*	500	9.000
3,5 x 19	*	*	500	9.000
3,5 x 22	*	*	500	4.500
3,5 x 25	*	*	500	4.500
3,9 x 13	*	*	500	9.000
3,9 x 16	*	*	500	9.000
3,9 x 19	*	*	500	4.500
3,9 x 22	*	*	200	3.600
3,9 x 25	*	*	200	3.600
3,9 x 32	*	*	200	3.600
3,9 x 38	*	*	200	1.800
4,2 x 13	*	*	500	9.000
4,2 x 16	*	*	500	4.500
4,2 x 19	*	*	500	4.500
4,2 x 22	*	*	200	3.600
4,2 x 25	*	*	200	3.600
4,2 x 32	*	*	200	3.600
4,2 x 38	*	*	200	1.800
4,2 x 45	*	*	200	1.200
4,8 x 13	*	*	200	3.600
4,8 x 16	*	*	200	3.600
4,8 x 19	*	*	200	3.600
4,8 x 22	*	*	200	3.600
4,8 x 25	*	*	200	1.800
4,8 x 32	*	*	200	1.800
4,8 x 38	*	*	200	1.800
4,8 x 45	*	*	200	1.200
4,8 x 50	*	*	200	1.200
4,8 x 60	*	*	100	600
5,5 x 19	*	*	200	3.600
5,5 x 22	*	*	200	1.800
5,5 x 25	*	*	200	1.800
5,5 x 32	*	*	200	1.800
5,5 x 38	*	*	200	1.200
5,5 x 45	*	*	200	1.200
5,5 x 50	*	*	100	900
5,5 x 60	*	*	100	600

DIN 7504-K

Hexagonal rosca chapa autotaladrante

Hexagonal head self drilling screw

Vis à tôle autoperceuse tête hexagonale

Medida Size Dimension	Cincado Zinc plated Zingué	Envasado Packing Emboîtage	Embalaje Carton Emballage
mm.	€/1.000	Und.	Und.
3,5 x 13	*	500	9.000
3,5 x 16	*	500	9.000
3,5 x 19	*	500	9.000
3,5 x 22	*	500	4.500
3,5 x 25	*	500	4.500
3,5 x 32	*	200	3.600
4,2 x 13	*	500	9.000
4,2 x 16	*	500	4.500
4,2 x 19	*	500	4.500
4,2 x 22	*	200	3.600
4,2 x 25	*	200	3.600
4,2 x 32	*	200	3.600
4,2 x 38	*	200	1.800
4,8 x 13	*	200	3.600
4,8 x 16	*	200	3.600
4,8 x 19	*	200	3.600
4,8 x 22	*	200	3.600
4,8 x 25	*	200	1.800
4,8 x 32	*	200	1.800
4,8 x 38	*	200	1.800
4,8 x 45	*	200	1.200
4,8 x 50	*	200	1.200
4,8 x 60	*	100	600
5,5 x 19	*	200	3.600
5,5 x 22	*	200	1.800
5,5 x 25	*	200	1.800
5,5 x 32	*	200	1.800
5,5 x 38	*	200	1.200
5,5 x 45	*	200	1.200
5,5 x 50	*	200	1.200
5,5 x 60	*	100	600
6,3 x 19	*	200	1.800
6,3 x 22	*	200	1.800
6,3 x 25	*	200	1.800
6,3 x 32	*	200	1.200
6,3 x 38	*	200	1.200
6,3 x 45	*	100	900
6,3 x 50	*	100	600
6,3 x 60	*	100	600
6,3 x 70	*	100	600
6,3 x 80	*	100	600
6,3 x 90	*	100	600
6,3 x 100	*	50	300
6,3 x 110	*	50	300
6,3 x 120	*	50	300
6,3 x 140	*	50	300



Especificaciones en pág. 146



869/4

Cabeza Hexagonal
Aprieta-tuercas
1/4" x 65



869/4 M

Cabeza Hexagonal
Aprieta-tuercas magnético
1/4" x 65

Ø Tornillo (mm)



3,50	SW-5,5
3,90 - 4,20	SW-7
4,80 - 5,50	SW-8
6,30	SW-10

Especificaciones en pág. 134



Especificaciones en pág. 146



869/4
Cabeza Hexagonal
Aprieta-tuercas
1/4" x 65



869/4M
Cabeza Hexagonal
Aprieta-tuercas magnético
1/4" x 65

Ø Tornillo (mm)	
4,80 - 5,50	SW-8
6,30	SW-10

Especificaciones en pág. 134

DIN 7301

Hexagonal rosca chapa autotaladrante con arandela de goma 16 mm.

Hexagonal head self drilling screw with 16 mm. sealing washer

Vis a tôle autoperceuse tête hexagonale avec rondelle 16 mm.

Medida Size Dimension	Cincado Zinc plated Zingué	Envasado Packing Emboîtage	Embalaje Carton Emballage
mm.	€/1.000	Und.	Und.
4,8 x 16	*	200	1.800
4,8 x 19	*	200	1.800
4,8 x 25	*	200	1.200
4,8 x 32	*	200	1.200
4,8 x 38	*	200	1.200
4,8 x 45	*	200	1.200
4,8 x 50	*	100	600
4,8 x 60	*	100	600
5,5 x 22	*	200	1.200
5,5 x 25	*	200	1.200
5,5 x 32	*	200	1.200
5,5 x 38	*	200	1.200
5,5 x 45	*	100	600
5,5 x 50	*	100	600
5,5 x 60	*	100	600
5,5 x 70	*	100	600
6,3 x 25	*	200	1.200
6,3 x 32	*	100	600
6,3 x 38	*	100	600
6,3 x 50	*	100	600
6,3 x 60	*	100	600
6,3 x 70	*	50	300
6,3 x 80	*	100	600
6,3 x 90	*	50	300
6,3 x 100	*	50	300
6,3 x 120	*	50	300
6,3 x 130	*	50	300
6,3 x 140	*	50	300
6,3 x 150	*	50	300

* Consultar para arandela de Ø18 y Ø25. Consultar disponibilidad de cabezas de colores

* Inquire for washers Ø18 and Ø25. Check availability for colour heads.

* Renseignez-vous pour rondelles Ø18 et Ø25. Consulter disponibilité des têtes de couleur.

Medida Size Dimension	Envasado Packing Emboîtage
mm.	Und.
4,8 x 19	1.000
5,5 x 22	1.000

* Consultar precio y disponibilidad

* Check price and availability.

* Vérifier le prix et la disponibilité

ARANDELA DE CLOROPRENO

Arandela de estanqueidad de acero con EPDM

Steel and bonded EPDM washer

Rondelle acier et EPDM

Medida Size Dimension	Cincado Zinc plated Zingué	Envasado Packing Emboîtage	Embalaje Carton Emballage
mm.	€/1.000	Und.	Und.
P-14	*	500	4.500
P-16	*	500	4.500
P-18	*	500	3.000
P-25	*	500	3.000



LOTU[®]

The fixing brand

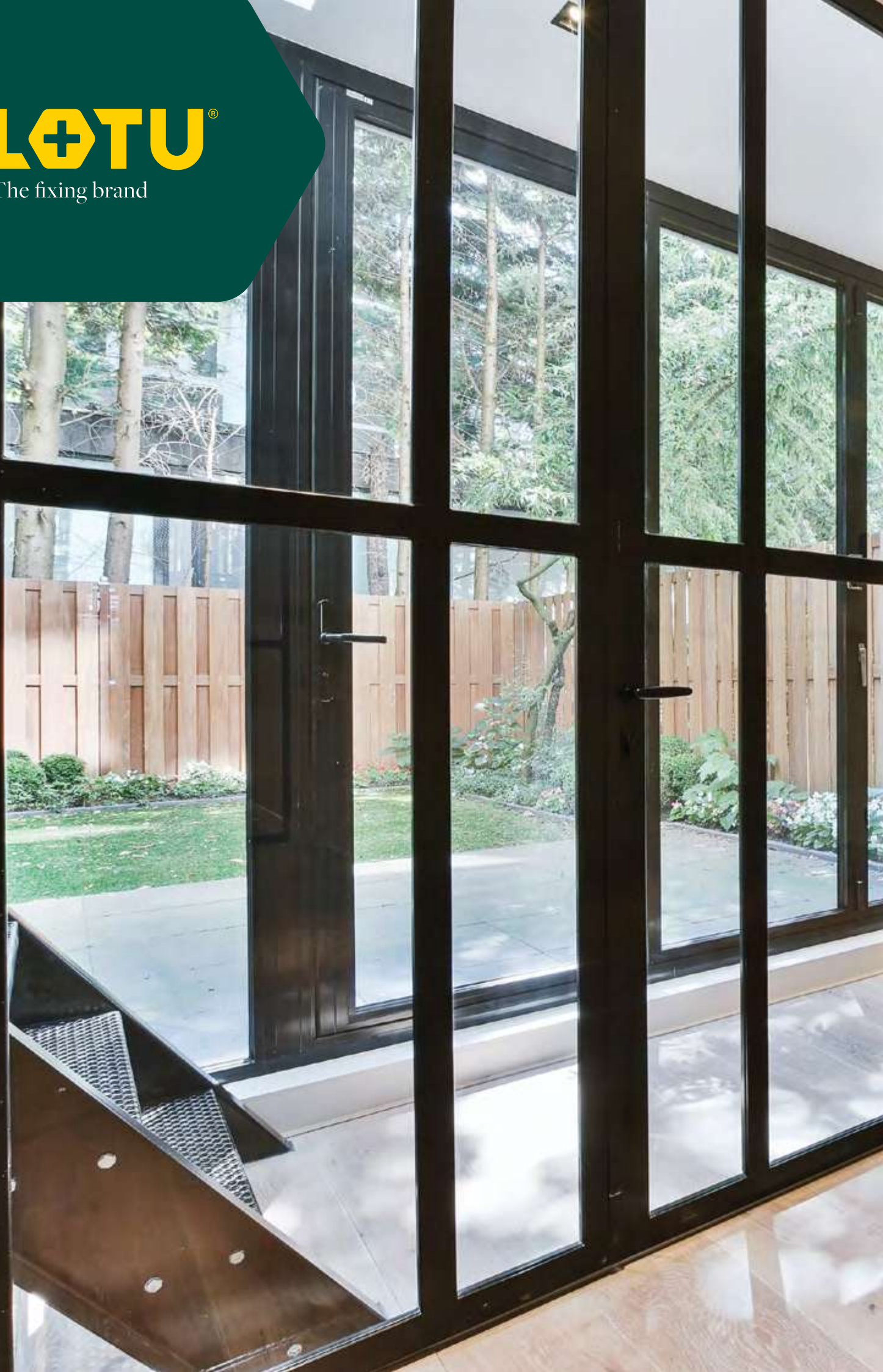



Carpintería aluminio

Screws for aluminium frames

Vis pour charpentes



Especificaciones en pág. 146



851/1TZ
Cruz philips
Punta atornillador
1/4" x 25



851/4TZ
Cruz philips
Punta atornillador
1/4" x 50

Ø Tornillo (mm) 

4,20 - 4,80 PH-2
5,50 PH-3

Especificaciones en pág. 134

AL - 81

Envolvente philips rosca chapa

Special cap philips head self tapping screw

Vis a tôle tête enveloppant philips

Medida Size Dimension	Cincado Zinc plated Zingué	Envasado Packing Emboîtage	Embalaje Carton Emballage
mm.	€/1.000	Ud.	Ud.
4,2 x 13	*	500	9.000
4,2 x 16	*	500	4.500
4,2 x 19	*	500	4.500
4,2 x 25	*	200	3.600
4,2 x 32	*	200	3.600
4,8 x 19	*	200	3.600
4,8 x 22	*	200	3.600
4,8 x 25	*	200	1.800
4,8 x 32	*	200	1.800
4,8 x 38	*	200	1.800
4,8 x 50	*	200	1.200
4,8 x 60	*	100	600
5,5 x 13	*	200	3.600
5,5 x 16	*	200	3.600
5,5 x 22	*	200	1.800
5,5 x 25	*	200	1.800
5,5 x 32	*	200	1.800
5,5 x 38	*	200	1.200
5,5 x 45	*	200	1.200
5,5 x 50	*	100	900
5,5 x 60	*	100	600
5,5 x 70	*	100	600



TP - ENV

Tapón plástico para tornillo envolvente

Plastic cap for special cap slotted head self tapping screw

Bouchon a plastique pour vis a tôle tête enveloppant



Colores disponibles
Colours / Couleurs

Precio Price Prix	Envasado Packing Emboîtage	Embalaje Carton Emballage
€/1.000	Und.	Und.
*	1.000	9.000

AL - CE

Cabeza plana philips con cono (tornillo para cierre)

Philips special head self tapping screw

Vis a tôle tête cylindrique spécial philips

Medida Size Dimension	Cincado Zinc plated Zingué	Cincado Negro Black Zinc plated Zingué Noir	Lacado Blanco White painted Laqué Blanc	Envasado Packing Emboîtage	Embalaje Carton Emballage
mm.	€/1.000	€/1.000	€/1.000	Und.	Und.
4,2 x 10	*	*	*	500	9.000
4,2 x 13	*	*	*	500	9.000
4,2 x 22	*	*	*	200	3.600
4,2 x 32	*	*	*	200	3.600



Ø Tornillo (mm)



4,20

PH-2

Especificaciones en pág. 134

AL - CE BRO

Cabeza plana philips con cono broca (tornillo para cierre)

Philips special head self drilling screw

Vis a tôle autoperceuse tête cylindrique spécial philips

Medida Size Dimension	Cincado Zinc plated Zingué	Cincado Negro Black Zinc plated Zingué Noir	Lacado Blanco White painted Laqué Blanc	Envasado Packing Emboîtage	Embalaje Carton Emballage
mm.	€/1.000	€/1.000	€/1.000	Und.	Und.
4,2 x 13	*	*	*	500	9.000
4,2 x 22	*	*	*	200	3.600
4,2 x 32	*	*	*	200	3.600



Ø Tornillo (mm)



4,20

PH-2

Especificaciones en pág. 134

DIN 7991 - 8.8

Cabeza plana allen tornillo para escuadras

Allen countersunk head machine screw

Vis a métaux tête fraisée empreinte allen

Medida Size Dimension	Cincado Zinc plated Zingué	Cincado Negro Black Zinc plated Zingué Noir	Envasado Packing Emboîtage	Embalaje Carton Emballage
mm.	€/1.000	€/1.000	Und.	Und.
M-6 x 13	*	*	200	1.800



Ø Tornillo (mm)



M-6

4

Especificaciones en pág. 134



Ø Tornillo (mm)



4,20

PH-2

Especificaciones en pág. 134

AL X PLA

Tornillo cabeza baja philips

Philips low head screw

Vis a tôle tête Extraplate philips

Medida Size Dimension	Cincado Zinc plated Zingué	Envasado Packing Emboîtage	Embalaje Carton Emballage
mm.	€/1.000	Und.	Und.
4,2 x 9,5	*	500	9.000
4,2 x 13	*	500	9.000
4,2 x 16	*	500	4.500
4,2 x 19	*	500	4.500



Ø Tornillo (mm)



3,50 - 4,20

PH-2

Especificaciones en pág. 134

AL X PLA BRO

Tornillo cabeza baja philips punta broca

Philips low head self drilling screw

Vis a tôle autoperceuse tête Extraplate philips

Medida Size Dimension	Cincado Zinc plated Zingué	Envasado Packing Emboîtage	Embalaje Carton Emballage
mm.	€/1.000	Und.	Und.
3,5 x 9,5	*	500	9.000
3,5 x 13	*	500	9.000
3,5 x 16	*	500	4.500
4,2 x 13	*	500	9.000
4,2 x 16	*	500	4.500
4,2 x 19	*	500	4.500

AL - JR

Tornillo para junquillo cabeza redonda

Rounded moulding screw

Vis tête ronde spécial

Medida Size Dimension	Cincado Zinc plated Zingué	Envasado Packing Emboitage	Embalaje Carton Emballage
mm.	€/1.000	Und.	Und.
4,2 x 5	*	1.000	18.000
3/16 x 5	*	1.000	18.000
8 x 3/8	*	500	9.000



AL - JP

Tornillo para junquillo cabeza plana

Rounded moulding countersunk screw

Vis tête fraisée spécial

Medida Size Dimension	Cincado Zinc plated Zingué	Envasado Packing Emboitage	Embalaje Carton Emballage
mm.	€/1.000	Und.	Und.
4,2 x 5	*	1.000	18.000
3/16 x 5	*	1.000	18.000
8 x 3/8	*	500	9.000



LOTU[®]

The fixing brand





Carpintería PVC

PVC application screw

Vis pour application au PVC



Ø Tornillo (mm) 
3,90 - 4,80 PH-2

Especificaciones en pág. 134

CPV 10

Cabeza plana philips rosca plástico HI-LO cabeza 7,5 mm

7,5 mm head philips countersunk plastic Hi-Lo thread screw

Vis a plastique filet Hi-Lo 7,5 mm. tête fraisée philips

Medida Size Dimension	Cincado Zinc plated Zingué	Envasado Packing Emboîtage	Embalaje Carton Emballage
mm.	€/1.000	Und.	Und.
3,9 x 16	*	500	9.000
3,9 x 19	*	500	4.500
3,9 x 30	*	500	3.000
3,9 x 38	*	200	1.800
4,2 x 25	*	200	1.800
4,8 x 38	*	200	1.800



Ø Tornillo (mm) 
4,30 - 4,80 PH-2

Especificaciones en pág. 134

CPV 20

Cabeza plana philips rosca 40° cabeza 7,5 mm

7,5 mm head philips countersunk 40° thread

Vis a bois tête fraisée philips 40° 7,5 mm

Medida Size Dimension	Cincado Zinc plated Zingué	Envasado Packing Emboîtage	Embalaje Carton Emballage
mm.	€/1.000	Und.	Und.
4,3 x 19	*	500	4.500
4,3 x 25	*	500	4.500
4,3 x 30	*	500	3.000
4,3 x 38	*	200	1.800
4,3 x 45	*	200	1.800
4,8 x 25	*	500	4.500



Ø Tornillo (mm) 
M-4 PH-2

Especificaciones en pág. 134

CPV 50

Cabeza plana philips rosca métrica autotaladrante

Philips countersunk head self drilling machine screw

Vis a metaux autoperceuse tête fraisée

Medida Size Dimension	Cincado Zinc plated Zingué	Envasado Packing Emboîtage	Embalaje Carton Emballage
mm.	€/1.000	Und.	Und.
M-4 x 13	*	500	4.500
M-4 x 16	*	500	4.500
M-4 x 19	*	500	3.000
M-4 x 25	*	500	3.000
M-4 x 32	*	500	3.000

CPV - FM

Tornillo Torx (T-30) Fijación de marcos bicromatado

TX window frame screw

Vis TX pour cadre de fenêtre

Medida Size Dimension	Precio Price Pri x	Envasado Packing Emboîtage	Embalaje Carton Emballage
mm.	€/1.000	Und.	Und.
7,5 x 72	*	100	600
7,5 x 92	*	100	600
7,5 x 112	*	100	600
7,5 x 132	*	100	600
7,5 x 152	*	50	300
7,5 x 182	*	50	200
7,5 x 212	*	50	200



CPV - 35

Cabeza plana philips con estrías autotaladrante

Philips countersunk head self drilling screw

Vis a tête autoperceuse tête fraisée philips

Medida Size Dimension	Precio Price Pri x	Envasado Packing Emboîtage	Embalaje Carton Emballage
mm.	€/1.000	Und.	Und.
3,9 x 13	*	500	9.000
3,9 x 16	*	500	9.000
3,9 x 19	*	500	4.500
3,9 x 22	*	200	3.600
3,9 x 25	*	200	3.600
3,9 x 32	*	200	3.600
3,9 x 38	*	200	1.800



Ø Tornillo (mm) 

3,90 PH-2

Especificaciones en pág. 134

LOTU[®]

The fixing brand





Cubiertas y fachadas

Roofing and cladding screws

Vis pour des façades et des couvertures



Tapón CF-CAP
Cap / Bouchon



Colores disponibles
Colours / Couleurs

Ø Tornillo (mm)



6,30

SW-10

Especificaciones en pág. 134

DIN 6928 - ARAN

Cabeza hexagonal rosca chapa con arandela de estanqueidad 16 mm

Hexagonal head self tapping screw with 16 mm. sealing washer

Vis a tôle tête hexagonale zingué avec rondelle 16 mm

Medida Size Dimension	Cincado Zinc plated Zingué	Envasado Packing Emboitage	Embalaje Carton Emballage
mm.	€/1.000	Und.	Und.
6,3 x 19	*	200	1.800
6,3 x 25	*	200	1.800
6,3 x 38	*	200	1.200
6,3 x 50	*	100	600
6,3 x 60	*	100	600
6,3 x 80	*	100	600
6,3 x 90	*	50	300
6,3 x 100	*	50	300
6,3 x 110	*	50	300
6,3 x 120	*	50	300
6,3 x 130	*	50	300
6,3 x 140	*	50	300
6,3 x 150	*	50	300
6,3 x 170	*	50	200
6,3 x 200	*	50	200

* Consultar para arandela de Ø18 y Ø25.

* Inquire for washers Ø18 and Ø25.

* Renseignez-vous pour rondelles Ø18 et Ø25.



Ø Tornillo (mm)



6,30

SW-10

Especificaciones en pág. 134

DIN 6928

Cabeza hexagonal rosca chapa

Hexagonal head self tapping

Vis a tôle tête hexagonale

Medida Size Dimension	Cincado Zinc plated Zingué	Envasado Packing Emboitage	Embalaje Carton Emballage
mm.	€/1.000	Und.	Und.
6,3 x 19	*	200	1.800
6,3 x 25	*	200	1.800
6,3 x 35	*	200	1.800
6,3 x 40	*	200	1.200
6,3 x 50	*	200	1.200
6,3 x 60	*	100	600
6,3 x 70	*	100	600
6,3 x 80	*	100	600

DIN 7504 - K

Cabeza hexagonal rosca chapa

Hexagonal head self drilling screw

Vis à tôle autoperceuse tête hexagonale

Medida Size Dimension	Cincado Zinc plated Zingué	Envasado Packing Emboitage	Embalaje Carton Emballage
mm.	€/1.000	Und.	Und.
3,5 x 13	*	500	9.000
3,5 x 16	*	500	9.000
3,5 x 19	*	500	9.000
3,5 x 22	*	500	4.500
3,5 x 25	*	500	4.500
3,5 x 32	*	200	3.600
4,2 x 13	*	500	9.000
4,2 x 16	*	500	4.500
4,2 x 19	*	500	4.500
4,2 x 22	*	200	3.600
4,2 x 25	*	200	3.600
4,2 x 32	*	200	3.600
4,2 x 38	*	200	1.800
4,8 x 13	*	200	3.600
4,8 x 16	*	200	3.600
4,8 x 19	*	200	3.600
4,8 x 22	*	200	3.600
4,8 x 25	*	200	1.800
4,8 x 32	*	200	1.800
4,8 x 38	*	200	1.800
4,8 x 45	*	200	1.200
4,8 x 50	*	200	1.200
4,8 x 60	*	100	600
5,5 x 19	*	200	3.600
5,5 x 22	*	200	1.800
5,5 x 25	*	200	1.800
5,5 x 32	*	200	1.800
5,5 x 38	*	200	1.200
5,5 x 45	*	200	1.200
5,5 x 50	*	200	1.200
5,5 x 60	*	100	600
6,3 x 19	*	200	1.800
6,3 x 22	*	200	1.800
6,3 x 25	*	200	1.800
6,3 x 32	*	200	1.200
6,3 x 38	*	200	1.200
6,3 x 45	*	100	900
6,3 x 50	*	100	600
6,3 x 60	*	100	600
6,3 x 70	*	100	600
6,3 x 80	*	100	600
6,3 x 90	*	100	600
6,3 x 100	*	50	300
6,3 x 110	*	50	300
6,3 x 120	*	50	300
6,3 x 140	*	50	300



Especificaciones en pág. 146



869/4

Cabeza Hexagonal
Aprieta-tuercas
1/4" x 65



869/4 M

Cabeza Hexagonal
Aprieta-tuercas magnético
1/4" x 65

Ø Tornillo (mm)



3,50	SW-5,5
3,90 - 4,20	SW-7
4,80 - 5,50	SW-8
6,30	SW-10

Especificaciones en pág. 134



Ø Tornillo (mm)

4,80 - 5,50

6,30



SW-8

SW-10

Especificaciones en pág. 134

DIN 7301

Cabeza hexagonal rosca chapa autotaladrante con arandela de estanqueidad 16 mm

Hexagonal head self drilling screw with 16 mm. sealing washer

Vis a tôle autoperceuse tête hexagonale avec rondelle 16 mm

Medida Size Dimension	Cincado Zinc plated Zingué	Envasado Packing Emboitage	Embalaje Carton Emballage
mm.	€/1.000	Und.	Und.
4,8x16	*	200	1.800
4,8 x 19	*	200	1.800
4,8 x 25	*	200	1.200
4,8 x 32	*	200	1.200
4,8 x 38	*	200	1.200
4,8 x 45	*	200	1.200
4,8 x 50	*	100	600
4,8 x 60	*	100	600
5,5 x 22	*	200	1.200
5,5 x 25	*	200	1.200
5,5 x 32	*	200	1.200
5,5 x 38	*	200	1.200
5,5 x 45	*	100	600
5,5 x 50	*	100	600
5,5 x 60	*	100	600
5,5 x 70	*	100	600
6,3 x 25	*	200	1.200
6,3 x 32	*	100	600
6,3 x 38	*	100	600
6,3 x 50	*	100	600
6,3 x 60	*	100	600
6,3 x 70	*	50	300
6,3 x 80	*	100	600
6,3 x 90	*	50	300
6,3 x 100	*	50	300
6,3 x 120	*	50	300
6,3 x 130	*	50	300
6,3 x 140	*	50	300
6,3 x 150	*	50	300

* Consultar para arandela de Ø18 y Ø25.

* Inquire for washers Ø18 and Ø25.

* Renseignez-vous pour rondelles Ø18 et Ø25.

TORNILLO VIGA

Cabeza Hexagonal con arandela de estanqueidad 16 mm broca nº 5

Hexagonal head self drilling screw nº 5 with 16 mm. sealing washer

Vis a tôle autoperceuse nº 5 tête hexagonale avec rondelle 16 mm



Ø Tornillo (mm)

5,50



SW-8

Especificaciones en pág. 134

Medida Size Dimension	Cincado Zinc plated Zingué	Envasado Packing Emboitage	Embalaje Carton Emballage
mm.	€/1.000	Und.	Und.
5,5 x 32	*	200	1.200
5,5 x 38	*	200	1.200

ARANDELA ACERO/INOXIDABLE CON CLOROPRENO

Satinless /Steel washer with chloroprene
Rondelle en acier/A2 avec chloroprène

Medida Size Dimension	Acero Steel Acier	Inoxidable Stainless steel A2	Envasado Packing Emboîtage	Embalaje Carton Emballage
mm.	€/1.000	€/1.000	Und.	Und.
P-14	*	*	500	4.500
P-16	*	*	500	4.500
P-18	*	*	500	3.000
P-25	*	*	200	1.800



CF - RED

Tornillo hexagonal punta broca reducida

Hexagonal head reduced drill point

Vis a tôle autoperceuse tête hexagonale pointe réduite

Medida Size Dimension	Cincado Zinc plated Zingué	Envasado Packing Emboîtage	Embalaje Carton Emballage
mm.	€/1.000	Und.	Und.
6,3 x 20	*	200	1.800
6,3 x 25	*	200	1.800



Ø Tornillo (mm) 
6,30 SW-10

Especificaciones en pág. 134

CF - ARA RED

Tornillo hexagonal con arandela 16 mm punta broca reducida

Hexagonal screw with rubber washer and reduced drill bit tip

Vis à six pans avec rondelle en caoutchouc, pointe percée réduite

Medida Size Dimension	P - 16	Envasado Packing Emboîtage	Embalaje Carton Emballage
mm.	€/1.000	Und.	Und.
6,3 x 20	*	200	1.800
6,3 x 25	*	200	1.800
6,3 x 32	*	100	600
6,3 x 60	*	100	600



Ø Tornillo (mm) 
6,30 SW-10

Especificaciones en pág. 134



Ø Tornillo (mm)



4,80 - 5,50

SW-8

Especificaciones en pág. 134

CF - AIS RED

Cabeza hexagonal punta broca reducida para aislamiento

Hexagonal reduced drill bit tip for insulation

Pointe hexagonale réduite pour isolation

Medida Size Dimension	Bicromatado Yellow Zinc Plated Bichromaté	Envasado Packing Emboîtage	Embalaje Carton Emballage
mm.	€/1.000	Und.	Und.
4,8/5,5 x 60	*	100	900
4,8/5,5 x 80	*	100	900
4,8/5,5 x 100	*	100	600
4,8/5,5 x 120	*	100	600



CF - AIS PHI

Cabeza alomada philips rosca chapa para aislamiento

philips pan head self tapping for insulation

Vis a tôle cylindrique bombée philips pour isolement

Medida Size Dimension	Bicromatado Yellow Zinc Plated Bichromaté	Envasado Packing Emboîtage	Embalaje Carton Emballage
mm.	€/1.000	Und.	Und.
4,8/5,5 x 70	*	100	900
4,8/5,5 x 75	*	100	900
4,8/5,5 x 90	*	100	600
4,8/5,5 x 100	*	100	600
4,8/5,5 x 110	*	100	600



CF - NER

Arandela nervada

Roof deck connecting washer

Rondelle plate - forme de toit

Medida Size Dimension	Bicromatado Yellow Zinc Plated Bichromaté	Envasado Packing Emboîtage	Embalaje Carton Emballage
mm.	€/1.000	Und.	Und.
80 x 40 Rectangular	*	100	600
M-70 Redonda	*	100	600
M-40 Redonda	*	100	600

CF - NYLON

Tornillo cabeza nylon de colores

Colour nylon head tapping screw

Vis tête de nylon en différentes couleurs

Medida Size Dimension	Cincado Zinc plated Zingué	Envasado Packing Emboîtage	Embalaje Carton Emballage
mm.	€/1.000	Und.	Und.
6,3 x 19	*	200	1.800
6,3 x 25	*	200	1.800
6,3 x 40	*	200	1.200
6,3 x 60	*	100	600



Colores disponibles
Colours / Couleurs

CF - BNYLON

Tornillo punta broca cabeza nylon de colores

Colour nylon head self drilling screw

Vis tête de nylon en différentes couleurs autoperceuse

Medida Size Dimension	Cincado Zinc plated Zingué	Envasado Packing Emboîtage	Embalaje Carton Emballage
mm.	€/1.000	Und.	Und.
4,8 x 19	*	200	1.800
5,5 x 22	*	200	1.800
6,3 x 25	*	200	1.800
6,3 x 38	*	200	1.200
6,3 x 60	*	100	600



Colores disponibles
Colours / Couleurs

CF - RNYLON

Tornillo cabeza nylon de colores punta broca reducida

Colour nylon head reduced drill point screw

Vis tête de nylon en différentes couleurs autoperceuse pointe reduite

Medida Size Dimension	Cincado Zinc plated Zingué	Envasado Packing Emboîtage	Embalaje Carton Emballage
mm.	€/1.000	Und.	Und.
6,3 x 20	*	200	1.800
6,3 x 25	*	200	1.800



Colores disponibles
Colours / Couleurs



Colores disponibles
Colours / Couleurs

CF - CAP

Tapon nylon de colores para tornillo de cabeza hexagonal

Nylon cap for hexagonal head screws in colours

Bouchon nylon pour vis tête hexagonale, différentes couleurs

Medida Size Dimension	Precio Price Prix	Envasado Packing Emboitage	Embalaje Carton Emballage
mm.	€/1.000	Und.	Und.
c/ 8 mm.	*	200	1.200
c/10 mm.	*	200	1.200



CF - HOR

Tornillo hexagonal para hormigón

Concrete screw hexagonal head

Vis béton tête hexagonale

Medida Size Dimension	Precio Price Prix	Envasado Packing Emboitage	Embalaje Carton Emballage
mm.	€/1.000	Und.	Und.
6,5 x 32	*	200	1.200
6,5 x 45	*	100	600
6,5 x 57	*	100	600
6,5 x 70	*	100	600
6,5 x 80	*	100	600
6,5 x 100	*	50	300
6,5 x 115	*	50	300
6,5 x 125	*	50	300
6,5 x 150	*	50	300

CF - HORA

Tornillo hexagonal con arandela EPDM para hormigón

Concrete screw hexagonal head with EPDM washer

Vis béton tête hexagonale avec rondelle



Medida Size Dimension	P - 16 Arandela Washer Rondelle	Envasado Packing Emboîtage	Embalaje Carton Emballage
mm.	€/1.000	Und.	Und.
6,5 x 32	*	200	1.200
6,5 x 45	*	100	600
6,5 x 57	*	100	600
6,5 x 70	*	100	600
6,5 x 80	*	100	600
6,5 x 100	*	50	300

Medida Size Dimension	P - 18 Arandela Washer Rondelle	Envasado Packing Emboîtage	Embalaje Carton Emballage
mm.	€/1.000	Und.	Und.
6,5 x 32	*	200	1.200
6,5 x 45	*	100	600
6,5 x 57	*	100	600
6,5 x 70	*	100	600
6,5 x 80	*	100	600
6,5 x 100	*	50	300
6,5 x 115	*	50	300
6,5 x 125	*	50	300
6,5 x 150	*	50	300

Medida Size Dimension	P - 25 Arandela Washer Rondelle	Envasado Packing Emboîtage	Embalaje Carton Emballage
mm.	€/1.000	Und.	Und.
6,5 x 32	*	150	900
6,5 x 45	*	100	600
6,5 x 57	*	100	600
6,5 x 70	*	50	300
6,5 x 80	*	50	300
6,5 x 100	*	50	300



Ø Tornillo (mm)

5,50 - 6,30



SW-8

Especificaciones en pág. 134

CF - SAND

Tornillo hexagonal punta broca N° 3 panel sandwich

Hexagonal head self drilling No. 3 for sandwich panel

Vis a tôle autoperceuse N°3 tête hexagonale pour panneau sandwich

Medida Size Dimension	Bicromatado Yellow Zinc Plated Bichromaté	Envasado Packing Emboítage	Embalaje Carton Emballage
mm.	€/1.000	Und.	Und.
5,5/6,3 x 57	*	100	600
5,5/6,3 x 82	*	50	300
5,5/6,3 x 98	*	50	300
5,5/6,3 x 115	*	50	300

Medida Size Dimension	P - 16 Arandela Washer Rondelle	Envasado Packing Emboítage	Embalaje Carton Emballage
mm.	€/1.000	Und.	Und.
5,5/6,3 x 57	*	100	600
5,5/6,3 x 82	*	50	300
5,5/6,3 x 98	*	50	300
5,5/6,3 x 115	*	50	300
5,5/6,3 x 125	*	50	300



Ø Tornillo (mm)

5,50 - 6,30



SW-8

Especificaciones en pág. 134

CF - SANDAL

Tornillo hexagonal punta broca alta panel sandwich

Hex head self drilling for sandwich panel

Vis a tôle autoperceuse N°5 tête hexagonale pour panneau sandwich

Medida Size Dimension	Bicromatado Yellow Zinc Plated Bichromaté	Envasado Packing Emboítage	Embalaje Carton Emballage
mm.	€/1.000	Und.	Und.
5,5/6,3 x 75	*	100	600
5,5/6,3 x 105	*	50	300
5,5/6,3 x 115	*	50	300
5,5/6,3 x 130	*	50	300
5,5/6,3 x 150	*	50	300

Medida Size Dimension	P - 16 Arandela Washer Rondelle	Envasado Packing Emboítage	Embalaje Carton Emballage
mm.	€/1.000	Und.	Und.
5,5/6,3 x 75	*	50	300
5,5/6,3 x 105	*	50	300
5,5/6,3 x 115	*	50	300
5,5/6,3 x 130	*	50	300
5,5/6,3 x 150	*	50	300

CF - FIBRO

Tornillo punta broca alta c/ arandela para Fibrocemento

Hexagonal head self drilling with washer for fiber cement

Vis a tôle autoperceuse tête hexagonale pour fibrocement

Medida Size Dimension	Cincado Zinc plated Zingué	Envasado Packing Emboîtage	Embalaje Carton Emballage
mm.	€/1.000	Und.	Und.
6,3 x 110	*	50	300
6,3 x 120	*	50	300
6,3 x 130	*	50	300



Ø Tornillo (mm)



6,30

SW-10

Especificaciones en pág. 134

CF - ALA

Tornillo punta broca con aletas

Self drilling screw with wings

Vis a tôle autoperceuse avec ailettes

Medida Size Dimension	P - 16	Envasado Packing Emboîtage	Embalaje Carton Emballage
mm.	€/1.000	Und.	Und.
4,8 x 25	*	200	1.800
4,8 x 32	*	200	1.800
4,8 x 38	*	200	1.800
4,8 x 45	*	200	1.200
5,5 x 38	*	200	1.200
5,5 x 45	*	200	1.200
5,5 x 50	*	100	900
5,5 x 60	*	100	900
6,3 x 60	*	100	600
6,3 x 70	*	100	600
6,3 x 85	*	100	600



Ø Tornillo (mm)



4,80 - 5,50

PH-2

6,30

PH-3

Especificaciones en pág. 134

The logo for LOTU, featuring the letters 'LOTU' in a bold, yellow, sans-serif font. The letter 'O' is replaced by a yellow square containing a white plus sign. A registered trademark symbol (®) is located to the upper right of the 'U'.

LOTU[®]

The fixing brand





Electricista

Screws and accessories for electricians
Vis et accessoires pour électriciens



ELEC - 71

Tornillo sujeción elementos eléctricos cabeza redonda ranura

Slotted rounded head screw

Vis tête ronde fendue

Código Code Code	Medida Size Dimension	Cincado Zinc plated Zingué	Envasado Packing Emboîtage	Embalaje Carton Emballage
	mm.	€/1.000	Und.	Und.
02E741025	5,0 x 25	*	200	1.800
02E741030	5,0 x 30	*	200	1.800
02E741035	5,0 x 35	*	200	1.800
02E741040	5,0 x 40	*	200	1.800



ELEC - 81

Tornillo sujeción elementos eléctricos cabeza alomada pozi combi con arandela estampada

Combi slotted rounded head screw

Vis tête ronde fendue

Código Code Code	Medida Size Dimension	Cincado Zinc plated Zingué	Envasado Packing Emboîtage	Embalaje Carton Emballage
	mm.	€/1.000	Und.	Und.
12E612225	5,0 x 25	*	PZ-2 200	1.800
12E612230	5,0 x 30	*	PZ-2 200	1.800
12E612235	5,0 x 35	*	PZ-2 200	1.800
12E612240	5,0 x 40	*	PZ-2 200	1.800

Ø Tornillo (mm)



5,00

PZ-2

Especificaciones en pág. 134

BRIDAS NYLON

Color negro/blanco (poliamida 6.6)

Nylon cable tie black/white colour (polyamide 6.6)

Collier de serrage couleur noire/blanc (polyamide 6.6)

Medida Size Dimension	Precio Price Prix	Bolsa Bag Sachet
mm.	€/Bolsa	Und.
2,5 x 100	*	100
2,5 x 140	*	100
2,5 x 160	*	100
2,5 x 200	*	100
3,6 x 150	*	100
3,6 x 200	*	100
3,6 x 300	*	100
3,6 x 370	*	100
4,8 x 160	*	100
4,8 x 180	*	100
4,8 x 200	*	100
4,8 x 250	*	100
4,8 x 290	*	100
4,8 x 370	*	100
4,8 x 390	*	100
4,8 x 430	*	100
7,6 x 200	*	100
7,6 x 250	*	100
7,6 x 300	*	100
7,6 x 370	*	100
7,6 x 450	*	100
7,6 x 540	*	100
8,8 x 710	*	100
8,8 x 810	*	100
12,5 x 720	*	50
12,5 x 850	*	50
12,5 x 1.000	*	

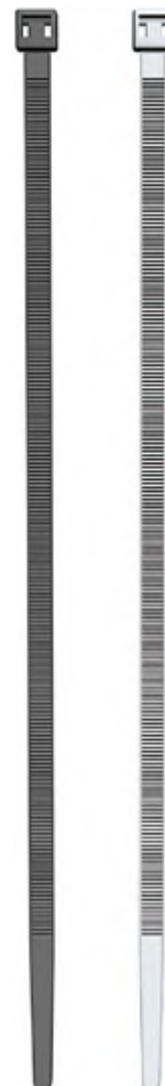

TACO BRIDA NEGRO

Plug cable tie black

Taquet collier noir

Medida Size Dimension	Precio Price Prix	Bolsa Bag Sachet
mm.	€/Bolsa	Und.
6 mm.	*	200
8 mm.	*	100



LOTU[®]

The fixing brand



Cartón-Yeso

Drywall screws and accessories

Vis et accessoires pour plaques de plâtre



***Incluimos una punta PH2 en cada caja**

*Including PH2 driving

*Nous incluons un embout PH2

PLA - F

Cabeza plana philips trompeta fosfatado

Drywall screw for plasterboard bugle head phosphated

Vis pour plaques de plâtre tête trompette acier phosphaté



EN 14592

Medida Size Dimension	Fosfatado Phosphated Phosphaté	Envasado Packing Emboîtage	Embalaje Carton Emballage
mm.	€/1.000	Und.	Und.
3,5 x 25	*	1.000	6.000
3,5 x 35	*	1.000	6.000
3,5 x 45	*	1.000	4.000
3,5 x 55	*	850	3.400
3,9 x 25	*	1.000	6.000
3,9 x 35	*	1.000	6.000
3,9 x 45	*	1.000	4.000
3,9 x 55	*	500	2.000
4,2 x 65	*	500	2.000
4,2 x 75	*	500	2.000
4,8 x 90	*	200	1.200
4,8 x 100	*	200	1.200
4,8 x 110	*	200	1.200
4,8 x 120	*	200	1.200
4,8 x 130	*	200	1.200



PLA - P

Tornillo placa - placa

Drywall screw for plasterboard bugle head phosphated

Vis pour plaques de plâtre tête trompette acier phosphaté

Medida Size Dimension	Fosfatado Phosphated Phosphaté	Envasado Packing Emboîtage	Embalaje Carton Emballage
mm.	€/1.000	Und.	Und.
4,8 x 35	*	1.000	4.000



PLA - B

Cabeza plana philips trompeta fosfatado punta broca

Drywall screw for plasterboard bugle head phosphated

Vis pour plaques de plâtre tête trompette acier phosphaté

Medida Size Dimension	Fosfatado Phosphated Phosphaté	Envasado Packing Emboîtage	Embalaje Carton Emballage
mm.	€/1.000	Und.	Und.
3,5 x 25	*	1.000	6.000
3,5 x 35	*	1.000	6.000
3,5 x 45	*	500	3.000



TORNILLO ENCINTADO

Collated screws / Vis sur bande

Medida Size Dimension	Precio Price Prix	Envasado Packing Emboîtage	Embalaje Carton Emballage
mm.	€/1.000	Und.	Und.
3,5 x 25	*	1.000	10.000
3,5 x 35	*	1.000	10.000

TACO DE NYLON SP AUTOPERFORANTE

SP nylon self drilling anchor / Cheville nylon SP autoperceuse

Código Code Code	Medida Size Dimension	Precio Price Prix	Envasado Packing Emboîtage	Embalaje Carton Emballage
	mm.	€/100	Und.	Und.
360005913	6 x 37	*	100	900



TACO ZAMAK AUTOPERFORANTE SPZ

Metal self drilling anchor / Cheville Zamak autoperceuse

Código Code Code	Medida Size Dimension	Precio Price Prix	Envasado Packing Emboîtage	Embalaje Carton Emballage
	mm.	€/100	Und.	Und.
360005913	6 x 37	*	100	900



TACO DE NYLON HAV

Nylon anchor HAV / Cheville nylon HAV

Código Code Code	Medida Size Dimension	Precio Price Prix	Envasado Packing Emboîtage	Embalaje Carton Emballage
	mm.	€/100	Und.	Und.
360005937	10 x 38	*	50	450
360005944	17 x 47	*	50	450



TACO CLAVABLE CABEZA CILÍNDRICA (Premontado)

Screw nails anchor flat head / Chevilles à fraper tête plate

Código Code Code	Medida Size Dimension	Precio Price Prix	Envasado Packing Emboîtage	Embalaje Carton Emballage
	mm.	€/100	Und.	Und.
36TACOCLA530	5 x 30	*	200	1.800
36TACOCLA535	5 x 35	*	200	1.800
36TACOCLA640	6 x 40	*	100	600
36TACOCLA660	6 x 60	*	100	600
36TACOCLA880	8 x 80	*	50	600
36TACOCLA8100	8 x 100	*	50	600



TACO FIJACIÓN AISLANTE

Insulation anchor / Chevilles d'isolation

Código Code Code	Medida Size Dimension	Precio Price Prix	Envasado Packing Emboîtage	Embalaje Carton Emballage
	mm.	€/100	Und.	Und.
24TACOAIS1070	10/70	*	250	250
24TACOAIS1090	10/90	*	250	250
24TACOAIS10120	10/120	*	250	250
24TACOAIS10140	10/140	*	250	250
24TACOAIS10160	10/160	*	250	250
24TACOAIS10180	10/180	*	250	250
24TACOAIS10200	10/200	*	250	250



LOTU[®]

The fixing brand





Acero Inoxidable

Stainless steel

Acier inoxydable



Especificaciones en pág. 146



855/1 TH Extra Dura

Cruz pozidriv
Punta atornillador
1/4" x 25



855/4 TH Extra Dura

Cruz pozidriv
Punta atornillador
1/4" x 50

Ø Tornillo (mm)



2,50 - 3,00	PZ-1
3,50 - 4,50	PZ-2
5,00	PZ-3

Especificaciones en pág. 134

7505-A (PZ) INOXIDABLE

Cabeza plana pozi rosca un hilo 40°

Pozi countersunk head chipboard screw stainless steel coating

Vis a bois aglomerée filet tête fraisée pozi en acier inoxydable

Medida Size Dimension	Envasado Packing Emboitage	Embalaje Carton Emballage
mm.	Und.	Und.
2,5 x 16	1.000	18.000
2,5 x 20	1.000	9.000
2,5 x 25	1.000	9.000
2,5 x 30	1.000	9.000
3,0 x 12	1.000	18.000
3,0 x 16	1.000	9.000
3,0 x 20	1.000	9.000
3,0 x 25	500	4.500
3,0 x 30	500	4.500
3,0 x 35	500	4.500
3,0 x 40	500	3.000
3,5 x 12	1.000	9.000
3,5 x 16	1.000	9.000
3,5 x 20	1.000	9.000
3,5 x 25	500	4.500
3,5 x 30	500	4.500
3,5 x 35	500	4.500
3,5 x 40	500	3.000
3,5 x 45	500	3.000
3,5 x 50	200	1.800
4,0 x 16	500	9.000
4,0 x 20	500	4.500
4,0 x 25	500	4.500
4,0 x 30	500	4.500
4,0 x 35	500	3.000
4,0 x 40	500	3.000
4,0 x 45	200	1.800
4,0 x 50	200	1.800
4,0 x 60	200	1.200
4,0 x 70	200	1.200
4,5 x 20	500	4.500
4,5 x 25	500	3.000
4,5 x 30	500	3.000
4,5 x 35	500	3.000
4,5 x 40	200	1.800
4,5 x 45	200	1.800
4,5 x 50	200	1.200
4,5 x 60	200	1.200
4,5 x 70	100	900
4,5 x 80	100	900
5,0 x 30	200	1.800
5,0 x 35	200	1.800
5,0 x 40	200	1.800
5,0 x 45	200	1.200
5,0 x 50	200	1.200
5,0 x 60	100	900
5,0 x 70	100	900
5,0 x 80	100	900
5,0 x 90	100	900
5,0 x 100	100	600
6,0 x 60	100	600
6,0 x 70	100	600
6,0 x 80	100	600
6,0 x 100	100	600
6,0 x 120	100	600

*** Consultar precio y disponibilidad**

* Check price and availability

* Vérifier le prix et la disponibilité

DIN 7981 INOXIDABLE

Cabeza alomada philips

Philips pan head self tapping screw stainless steel coating

Vis a tôle tête cylindrique bombée large philips en acier inoxydable

Medida Size Dimension	Envasado Packing Emboîtage	Embalaje Carton Emballage
mm.	Und.	Und.
2,9 x 13	500	9.000
2,9 x 16	500	9.000
2,9 x 19	500	9.000
2,9 x 22	500	9.000
2,9 x 25	500	9.000
2,9 x 32	500	9.000
3,5 x 6,5	500	9.000
3,5 x 9,5	500	9.000
3,5 x 13	500	9.000
3,5 x 16	500	9.000
3,5 x 19	500	9.000
3,5 x 22	500	4.500
3,5 x 25	500	4.500
3,5 x 32	200	3.600
3,5 x 38	200	1.800
3,9 x 9,5	500	9.000
3,9 x 13	500	9.000
3,9 x 16	500	9.000
3,9 x 19	500	4.500
3,9 x 22	200	3.600
3,9 x 25	200	3.600
3,9 x 32	200	3.600
3,9 x 38	200	1.800
3,9 x 45	200	1.800
4,2 x 9,5	500	9.000
4,2 x 13	500	9.000
4,2 x 16	500	4.500
4,2 x 19	500	4.500
4,2 x 22	200	3.600
4,2 x 25	200	3.600
4,2 x 32	200	3.600
4,2 x 38	200	1.800
4,2 x 45	200	1.800
4,2 x 50	200	1.200
4,2 x 60	200	1.200
4,2 x 70	200	1.200
4,8 x 13	200	3.600
4,8 x 16	200	3.600
4,8 x 19	200	3.600
4,8 x 22	200	3.600
4,8 x 25	200	1.800
4,8 x 32	200	1.800
4,8 x 38	200	1.800
4,8 x 45	200	1.200
4,8 x 50	200	1.200
4,8 x 60	100	600
4,8 x 70	100	900
4,8 x 80	100	900
4,8 x 90	100	900
5,5 x 9,5	200	3.600
5,5 x 13	200	3.600
5,5 x 16	200	3.600
5,5 x 19	200	3.600
5,5 x 22	200	1.800
5,5 x 25	200	1.800



Especificaciones en pág. 146



851/1TZ
Cruz philips
Punta atornillador
1/4" x 25



851/4TZ
Cruz philips
Punta atornillador
1/4" x 50

Ø Tornillo (mm)	+
2,20 - 2,90	PH-1
3,20 - 4,80	PH-2
5,50 - 6,30	PH-3

Especificaciones en pág. 134



Especificaciones en pág. 146

*** Consultar precio y disponibilidad**

* Check price and availability

* Vérifier le prix et la disponibilité

DIN 7981 INOXIDABLE

Cabeza alomada philips

Philips pan head self tapping screw stainless steel coating

Vis a tête cylindrique bombée large philips en acier inoxydable

Medida Size Dimension	Envasado Packing Emboilage	Embalaje Carton Emballage
mm.	Und.	Und.
5,5 x 32	200	1.800
5,5 x 38	200	1.200
5,5 x 45	200	1.200
5,5 x 50	100	900
5,5 x 60	100	600
5,5 x 70	100	600
6,3 x 13	200	1.800
6,3 x 16	200	1.800
6,3 x 19	200	1.800
6,3 x 22	200	1.800
6,3 x 25	200	1.800
6,3 x 32	200	1.200
6,3 x 38	200	1.200



Especificaciones en pág. 146



851/1TZ

Cruz philips
Punta atornillador
1/4" x 25



851/4TZ

Cruz philips
Punta atornillador
1/4" x 50

Ø Tornillo (mm)



2,20 - 2,90	PH-1
3,20 - 4,80	PH-2
5,50 - 6,30	PH-3

Especificaciones en pág. 134

DIN 7982 INOXIDABLE

Cabeza plana philips

Philips pan head self tapping screw stainless steel coating

Vis a tête cylindrique bombée large philips en acier inoxydable

Medida Size Dimension	Envasado Packing Emboilage	Embalaje Carton Emballage
mm.	Und.	Und.
3,5x6,5	500	9.000
3,5x9,5	500	9.000
3,5x13	500	9.000
3,5x16	500	9.000
3,5x19	500	9.000
3,5x22	500	4.500
3,5x25	500	4.500
3,5x32	200	3.600
3,9x9,5	500	9.000
3,9x13	500	9.000
3,9x16	500	9.000
3,9x19	500	4.500
3,9x22	200	3.600
3,9x25	200	3.600
3,9x32	200	3.600
4,2x13	500	9.000
4,2x16	500	4.500
4,2x19	500	4.500
4,2x22	200	3.600
4,2x25	200	3.600
4,2x32	200	3.600
4,2x38	200	1.800
4,2x45	200	1.800
4,2x50	200	1.200
4,2x60	200	1.200
4,2x70	200	1.200

DIN 7982 INOXIDABLE

Cabeza plana philips

Philips pan head self tapping screw stainless steel coating

Vis a tôle tête cylindrique bombée large philips en acier inoxydable

Medida Size Dimension	Envasado Packing Emboitage	Embalaje Carton Emballage
mm.	Und.	Und.
4,8x13	200	3.600
4,8x16	200	3.600
4,8x19	200	3.600
4,8x22	200	3.600
4,8x25	200	1.800
4,8x32	200	1.800
4,8x38	200	1.800
4,8x45	200	1.200
4,8x50	200	1.200
4,8x60	100	600
4,8x70	100	900
4,8x80	100	900
4,8x90	100	900
5,5x9,5	200	3.600
5,5x13	200	3.600
5,5x16	200	3.600
5,5x19	200	3.600
5,5x22	200	1.800
5,5x25	200	1.800
5,5x32	200	1.800
5,5x38	200	1.200
5,5x45	200	1.200
5,5x50	100	900
5,5x60	100	600
5,5x70	100	600



Especificaciones en pág. 146



851/1TZ
Cruz philips
Punta atornillador
1/4" x 25



851/4TZ
Cruz philips
Punta atornillador
1/4" x 50

Ø Tornillo (mm)	+
2,20 - 2,90	PH-1
3,20 - 4,80	PH-2
5,50 - 6,30	PH-3

Especificaciones en pág. 134

*** Consultar precio y disponibilidad**

* Check price and availability

* Vérifier le prix et la disponibilité

DIN 571 INOXIDABLE

Cabeza hexagonal rosca tirafondo

Hexagon head wood screw stainless steel coating

Tête hexagonale tire-fond en acier inoxydable

Medida Size Dimension	Envasado Packing Emboitage	Embalaje Carton Emballage
mm.	Und.	Und.
6 x 40	100	500
6 x 50	100	500
6 x 60	100	300
6 x 70	100	600
6 x 80	100	600
6 x 90	100	600
6 x 100	100	600
8 x 50	100	300
8 x 60	100	300
8 x 70	100	300
8 x 80	100	300
8 x 90	50	300
8 x 100	50	300
10 x 80	50	300



Especificaciones en pág. 146

*** Consultar precio y disponibilidad**

* Check price and availability

* Vérifier le prix et la disponibilité



Especificaciones en pág. 146



869/4
Cabeza Hexagonal
Aprieta-tuercas
1/4" x 65



869/4 M
Cabeza Hexagonal
Aprieta-tuercas magnético
1/4" x 65

Ø Tornillo (mm)

M-6	SW-10
M-8	SW-13
M-10	SW-17

Especificaciones en pág. 134

*** Consultar precio y disponibilidad**

* Check price and availability

* Vérifier le prix et la disponibilité



Especificaciones en pág. 146

DIN 933 INOXIDABLE

Cabeza hexagonal

Hexagonal head machine screw stainless steel coating

Vis a métaux tête hexagonale en acier inoxydable

Medida Size Dimension	Envasado Packing Emboitage	Embalaje Carton Emballage
mm.	Und.	Und.
M-6 x 10	200	1.800
M-6 x 12	200	1.800
M-6 x 15	200	1.200
M-6 x 20	200	1.200
M-6 x 25	200	1.200
M-6 x 30	200	1.200
M-6 x 35	200	1.800
M-6 x 50	100	600
M-8 x 16	200	1.200
M-8 x 20	200	1.800
M-8 x 25	200	1.200
M-8 x 30	200	1.200
M-8 x 40	100	600
M-8 x 50	50	450
M-8 x 60	50	450
M-8 x 70	50	450
M-8 x 80	50	300
M-8 x 100	50	300
M-10 x 16	200	600
M-10 x 20	200	600
M-10 x 30	50	450
M-10 x 40	50	450
M-10 x 50	50	450
M-10 x 60	50	300
M-10 x 70	50	300
M-10 x 80	50	300
M-10 x 90	50	150
M-10 x 100	50	300

ARANDELA DIN 9021 INOXIDABLE

Stainless steel washer

Rondelle inoxydable

Medida Size Dimension	Envasado Packing Emboitage	Embalaje Carton Emballage
	Und.	Und.
M-4 INOX	100	800
M-6 INOX	100	800
M-8 INOX	100	800
M-10 INOX	100	900

ARANDELA DE CLOROPRENO INOXIDABLE

Arandela de estanqueidad de acero con EPDM

Steel and bonded EPDM washer

Rondelle acier et EPDM

Medida Size Dimension	Envasado Packing Emboitage	Embalaje Carton Emballage
	Und.	Und.
P-14 INOX	500	4.500
P-16 INOX	500	4.500
P-18 INOX	500	3.000
P-25 INOX	200	1.800
P-29 (Øint 8) INOX	200	1.800



Especificaciones
en pág. 146

TUERCA DIN 934 INOXIDABLE

Stainless steel hexagonal nuts

Écrou hexagonale inoxydable

Medida Size Dimension	Envasado Packing Emboitage	Embalaje Carton Emballage
	Und.	Und.
M-3 INOX	1.000	18.000
M-4 INOX	1.000	18.000
M-5 INOX	100	1.800
M-6 INOX	100	1.800
M-8 INOX	100	1.800
M-10 INOX	100	900



Especificaciones
en pág. 146

TUERCA DIN 6923 INOXIDABLE

Stainless steel hexagonal nuts

Écrou hexagonale inoxydable

Medida Size Dimension	Envasado Packing Emboitage	Embalaje Carton Emballage
	Und.	Und.
EST. M-4 INOX	1.000	9.000
EST. M-5 INOX	1.000	9.000



Especificaciones
en pág. 146

VARILLA ROSCADA INOXIDABLE

Stainless steel threaded rods

Tiges filetes inoxydable

Medida Size Dimension	Envasado Packing Emboitage	Embalaje Carton Emballage
	Und.	Und.
INOX M-6	50	50
INOX M-8	50	50
INOX M-10	25	25
INOX M-12	20	20
INOX M-14	10	10



LOTU[®]

The fixing brand

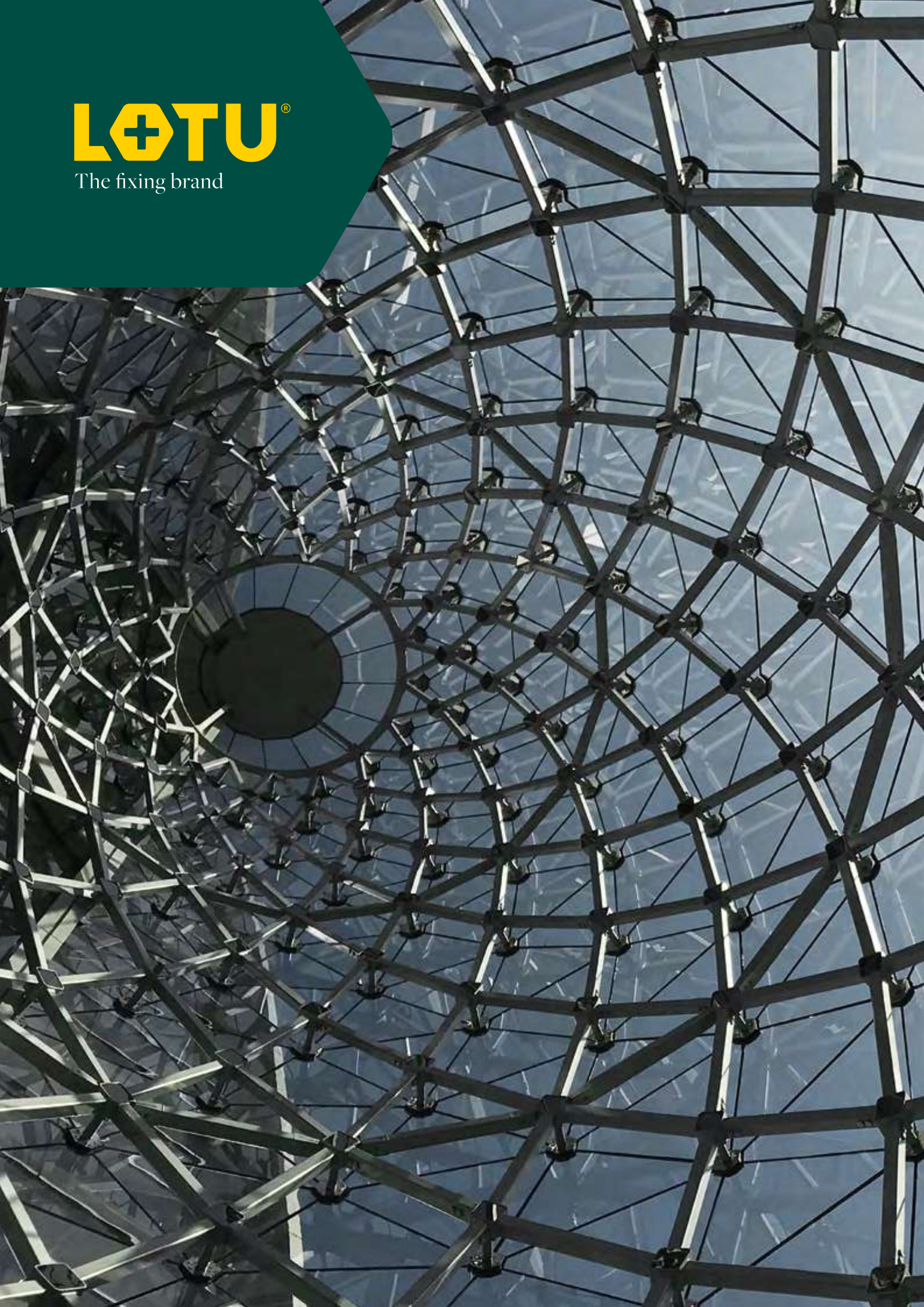



Fijaciones

Fastening products
Produits de fixation

FIJACIÓN CARGA PESADA

Fixing for heavy loads · Fixation pour charge lourde



ANCLAJE DROP HEMBRA

Heavy loads
Fixation lourde

Código Code Code	Medida Size Dimension	Precio Price Prix	Envasado Packing Emboitage	Embalaje Carton Emballage
	mm.	€/100	Und.	Und.
360053211	M-6 x 25 BIC	*	200	1.800
360053228	M-8 x 30 BIC	*	100	900
360053235	M-10 x 40 BIC	*	20	120
360053242	M-12 x 50 BIC	*	20	120
360053259	M-16 x 65 BIC	*	25	150



ANCLAJE LATÓN NTO

Brass NTO anchor
Cheville laiton NTO

Código Code Code	Medida Size Dimension	Precio Price Prix	Envasado Packing Emboitage	Embalaje Carton Emballage
	mm.	€/100	Und.	Und.
36TACOLA53216	5/32 x 16	*	300	7.500
36TACOLAM416	M-4 x 16	*	300	7.500
36TACOLAM623	M-6 x 23	*	200	1.800
36TACOLAM830	M-8 x 30	*	100	900

FIJACIÓN CARGA PESADA

Fixing for heavy loads · Fixation pour charge lourde

ANCLAJE METÁLICO CARGAS ALTAS

Heavy loads
Fixation lourde



Código Code Code	Medida Size Dimension	Precio Price Prix	Envasado Packing Emboîtage	Embalaje Carton Emballage
	mm.	€/1000	Und.	Und.
36AMCAM645	M-6 x 45 ZIN	*	100	300
36AMCAM660	M-6 x 60 ZIN	*	100	300
36AMCAM680	M-6 x 80 ZIN	*	100	300
36AMCAM6100	M-6 x 100 ZIN	*	100	300
36AMCAM6120	M-6 x 120 ZIN	*	50	150
36AMCAM850	M-8 x 50 ZIN	*	50	150
36AMCAM860	M-8 x 60 ZIN	*	50	150
36AMCAM875	M-8 x 75 ZIN	*	50	150
36AMCAM890	M-8 x 90 ZIN	*	50	150
36AMCAM8115	M-8 x 115 ZIN	*	50	150
36AMCAM8130	M-8 x 130 ZIN	*	50	150
36AMCAM1070	M-10 x 70 ZIN	*	50	150
36AMCAM1090	M-10 x 90 ZIN	*	50	150
36AMCAM10100	M-10 x 100 ZIN	*	25	75
36AMCAM10120	M-10 x 120 ZIN	*	25	75
36AMCAM10140	M-10 x 140 ZIN	*	25	75
36AMCAM10150	M-10 x 150 ZIN	*	25	75
36AMCAM10170	M-10 x 170 ZIN	*	25	75
36AMCAM1275	M-12 x 75 ZIN	*	25	75
36AMCAM1290	M-12 x 90 ZIN	*	25	75
36AMCAM12100	M-12 x 100 ZIN	*	20	60
36AMCAM12110	M-12 x 110 ZIN	*	20	60
36AMCAM12120	M-12 x 120 ZIN	*	20	60
36AMCAM12140	M-12 x 140 ZIN	*	20	60
36AMCAM12160	M-12 x 160 ZIN	*	20	60
36AMCAM12180	M-12 x 180 ZIN	*		20
36AMCAM12220	M-12 x 220 ZIN	*		20
36AMCAM14120	M-14 x 120 ZIN	*	15	45
36AMCAM14145	M-14 x 145 ZIN	*	15	45
36AMCAM14170	M-14 x 170 ZIN	*	15	45
36AMCAM1690	M-16 x 90 ZIN	*	15	45
36AMCAM16110	M-16 x 110 ZIN	*	15	45
36AMCAM16125	M-16 x 125 ZIN	*	10	30
36AMCAM16145	M-16 x 145 ZIN	*	10	30
36AMCAM16170	M-16 x 170 ZIN	*	10	30
36AMCAM20170	M-20 x 170 ZIN	*	5	15
36AMCAM20220	M-20 x 220 ZIN	*		5

FIJACIÓN CARGAS MEDIAS

Fixing for medium loads · Fixation pour charge moyenne



ANCLAJE CARGAS MEDIAS TORNILLO

Medium load anchor: screw

Ancrage à charge moyenne : vis

Código Code Code	Medida Size Dimension	Precio Price Prix	Envasado Packing Emboîtage	Embalaje Carton Emballage
	mm.	€/1000	Und.	Und.
36AMTORM645	M-6 x 45 Ø8 ZIN	*	100	300
36AMTORM660	M-6 x 60 Ø8 ZIN	*	100	300
36AMTORM860	M-8 x 60 Ø10 ZIN	*	50	150
36AMTORM880	M-8 x 80 Ø10 ZIN	*	50	150
36AMTORM1070	M-10 x 70 Ø12 ZIN	*	25	75
36AMTORM10100	M-10 x 100 Ø12 ZIN	*	25	75
36AMTORM1280	M-12 x 80 Ø16 ZIN	*	25	75
36AMTORM12110	M-12 x 110 Ø16 ZIN	*	25	75



ANCLAJE CARGAS MEDIAS ARGOLLA

Medium load anchor: ring

Ancrage à charge moyenne : anneau

Código Code Code	Medida Size Dimension	Precio Price Prix	Envasado Packing Emboîtage	Embalaje Carton Emballage
	mm.	€/1000	Und.	Und.
36AMARGM645	M-6 x 45 Ø8 ZIN	*	50	150
36AMARGM860	M-8 x 60 Ø10 ZIN	*	25	75
36AMARGM1070	M-10 x 70 Ø12 ZIN	*	10	30
36AMARGM1280	M-12 x 80 Ø16 ZIN	*	10	30



ANCLAJE CARGAS MEDIAS GANCHO

Medium load anchor: hook

Ancrage à charge moyenne : crochet

Código Code Code	Medida Size Dimension	Precio Price Prix	Envasado Packing Emboîtage	Embalaje Carton Emballage
	mm.	€/1000	Und.	Und.
36AMGANM645	M-6 x 45 Ø8 ZIN	*	50	150
36AMGANM860	M-8 x 60 Ø10 ZIN	*	25	75
36AMGANM1070	M-10 x 70 Ø12 ZIN	*	10	30
36AMGANM1280	M-12 x 80 Ø16 ZIN	*	10	30

FIJACIÓN CARGAS MEDIO LIGERAS

Medium-light loads · Fixation moyenne-légère

TACO DE NYLON N

Nylon plug type N
Cheville nylon N



Código Code Code	Medida Size Dimension	Precio Price Prix	Envasado Packing Emboîtage	Embalaje Carton Emballage
	mm.	€/100	Und.	Und.
360087766	5 x 25	*	200	3.600
360067928	6 x 30	*	100	1.800
360067935	8 x 40	*	100	900
360067942	10 x 50	*	100	600
360087674	12 x 60	*	50	300

TACO NYLON TOP CON Y SIN COLLARÍN

Nylon plug type TOP
Cheville nylon TOP



Código Code Code	Medida Size Dimension	Precio Price Prix	Envasado Packing Emboîtage	Embalaje Carton Emballage
	mm.	€/100	Und.	Und.
360007924	6 x 38	*	200	5.000
360007931	8 x 52	*	100	2.500
360007955	6 x 38 SB	*	200	5.000
360007962	8 x 51 SB	*	100	900
360007979	10 x 60 SB	*	100	900

TACO NYLON A

Nylon plug type A
Cheville nylon A



Código Code Code	Medida Size Dimension	Precio Price Prix	Envasado Packing Emboîtage	Embalaje Carton Emballage
	mm.	€/100	Und.	Und.
360004633	4 x 20	*	500	9.000
360004640	5 x 25	*	200	3.600
360075152	6 x 30	*	100	1.800
360075138	7 x 30	*	100	1.800
360075169	10 x 50	*	100	600
360004695	12 x 60	*	50	300
360004701	14 x 75	*	50	300
360008044	16 x 80	*	20	120

FIJACIÓN CARGAS MEDIO LIGERAS

Medium-light loads · Fixation moyenne-légère



TACO NYLON AB CON COLLARÍN

Nylon plug type AB (with collar)
Cheville nylon AB (avec collerette)

Código Code Code	Medida Size Dimension	Precio Price Prix	Envasado Packing Emboîtage	Embalaje Carton Emballage
	mm.	€/100	Und.	Und.
360004862	5 x 25	*	200	3.600
360004879	6 x 30	*	100	1.800
360004886	8 x 40	*	100	900
360004893	10 x 50	*	100	600



ESPECIAL APLICACIONES EXPLOTACIONES GANADERAS

Special applications for livestock farms · Applications spéciales pour les élevages

ANCLAJE METÁLICO INOX

Stainless steel metal anchor

Ancrage métallique en acier inoxydable

Código Code Code	Descripción Description Description	Precio Price Prix
	mm.	€/100
36TMXA26120	ANCLAJE TMX A2 M-6 x 120 INOX	*
36TMXA26130	ANCLAJE TMX A2 M-6 x 130 INOX	*
36TMXA26140	ANCLAJE TMX A2 M-6 x 140 INOX	*
36TMXA26150	ANCLAJE TMX A2 M-6 x 150 INOX	*
36TMXA26160	ANCLAJE TMX A2 M-6 x 160 INOX	*



ARANDELAS INOX

Stainless steel metal washers

Rondelles en acier inoxydable

Código Code Code	Descripción Description Description	Precio Price Prix
	mm.	€/100
14ARAN3092	ARAN CLOROP 9,2 CUE Ø30 INOX	*
14ARANDROM	ARAN ROMBO C/GOMA 40 x 40 INOX	*



LOTU[®]

The fixing brand



Tapones

Caps
Bouchons



Colores disponibles
Colours / Couleurs

TP - FONDO

Tapón plástico tipo tapa-fondo

Plastic cap for pan head self tapping screw

Bouchon a plastique pour vis tête cylindrique

Color Colour Couleur	Precio Price Prix	Envasado Packing Emboîtage	Embalaje Carton Emballage
	€/1.000	Und.	Und.
Blanco - White - Blanc	*	200	1.200
Negro - Black - Noir	*	200	1.200
Gris-Grey-Gris	*	200	1.200



Colores disponibles
Colours / Couleurs

TP - ENV

Tapón plástico para tornillo envolvente

Plastic cap for special cap slotted head self tapping screw

Bouchon a plastique pour vis a tôle tête enveloppant

Color Colour Couleur	Precio Price Prix	Envasado Packing Emboîtage	Embalaje Carton Emballage
	€/1.000	Und.	Und.
Blanco - White - Blanc	*	1.000	9.000
Negro - Black - Noir	*	1.000	9.000
Gris-Grey-Gris	*	1.000	9.000

TAPÓN - CAP - BOUCHON

Tapón plástico para tornillo (DIN 7504 / DIN 7981)

Plastic cap for philips pan head screw

Bouchon a plastique pour vis a tête cbl philips

Color Colour Couleur	Medida Size Dimension	Precio Price Prix	Envasado Packing Emboitage	Embalaje Carton Emballage
	mm.	€/1.000	Und.	Und.
Blanco - White - Blanc	Ø 4,2	*	1.000	9.000
Negro - Black - Noir	Ø 4,2	*	1.000	9.000
Blanco - White - Blanc	Ø 4,8	*	1.000	9.000
Negro - Black - Noir	Ø 4,8	*	1.000	9.000
Blanco - White - Blanc	Ø 5,5	*	1.000	9.000
Negro - Black - Noir	Ø 5,5	*	1.000	9.000



Colores disponibles
Colours / Couleurs

TP - CIL

Tapón cabeza cilíndrica TX-20

Plastic cap

Bouchon à plastique

Color Colour Couleur	Precio Price Prix	Envasado Packing Emboitage	Embalaje Carton Emballage
	€/1.000	Und.	Und.
Blanco - White - Blanc	*	1.000	9.000
Negro - Black - Noir	*	1.000	9.000



Colores disponibles
Colours / Couleurs



Colores disponibles
Colours / Couleurs



TP - ENS

Tapón plástico para tornillo ensamblaje N° 5 y N° 7

Plastic cap for furniture assembly screw

Bouchon a plastique pour vis pour assemblage a bois

Color Colour Couleur	Precio Price Prix	Envasado Packing Emboitage	Embalaje Carton Emballage
	€/1.000	Und.	Und.
Blanco-White-Blanc	*	1.000	9.000
Negro-Black-Noir *	*	1.000	9.000
Marrón-Brown-Marron	*	1.000	9.000
Roble-Oak colour-Rouvre*	*	1.000	9.000

*** No disponible para el N° 7**

* Not available for n° 7

* Non disponible pour n° 7



Colores disponibles
Colours / Couleurs



TP - ENS HI - LO

Tapón plástico para tornillo ensamblaje Rosca cortante Hi - Lo N° 5

Plastic cap for Ø 5 mm. furniture assembly screw Hi - Lo thread

Bouchon à plastique pour vis pour assemblage a bois Ø 5 mm. Hi - Lo

Color Colour Couleur	Precio Price Prix	Envasado Packing Emboitage	Embalaje Carton Emballage
	€/1.000	Und.	Und.
Blanco-White-Blanc	*	1.000	9.000
Marrón-Brown-Marron	*	1.000	9.000



Colores disponibles
Colours / Couleurs



TP - TORX®

Tapón plástico para tornillo cabeza plana Torx® 20-25

Plastic cap for TX countersunk head chipboard screw

Bouchon a plastique pour vis a bois aglomerée filet 40° tête fraisée TX

	Color Colour Couleur	Precio Price Prix	Envasado Packing Emboitage	Embalaje Carton Emballage
		€/1.000	Und.	Und.
TX-20	Blanco-White-Blanc	*	1.000	9.000
	Negro-Black-Noir	*	1.000	9.000
	Marrón-Brown-Marron	*	1.000	9.000
	Roble-Oak colour-Rouvre	*	1.000	9.000
TX-25	Blanco-White-Blanc	*	1.000	9.000
	Negro-Black-Noir	*	1.000	9.000
	Marrón-Brown-Marron	*	1.000	9.000
	Roble-Oak colour-Rouvre	*	1.000	9.000

TAPÓN ADHESIVO PARA TORNILLO CABEZA PLANA

Adhesive cap for countersunk head chipboard screw
Bouchon adhesif pour vis a bois aglomerée tête fraisée



Tapón adhesivo
Adhesiva Cap
Bouchon adhesif

Color Colour Couleur	Precio Price Prix	Envasado Packing Emboitage	Embalaje Carton Emballage
	€/1.000	Und.	Und.
Blanco - White - Blanc	*	1.000	9.000
Negro - Black - Noir	*	1.000	9.000
Pino - Pine - Pin	*	1.000	9.000
Roble - Oak colour - Rouvre	*	1.000	9.000
Nogal - Walnut - Noyer	*	1.000	9.000
Beige - Beige - Beige	*	1.000	9.000
Gris - Grey - Gris	*	1.000	9.000
Sapeli - Sapeli - Sapeli	*	1.000	9.000
Cerezo - Cherry - Cerise	*	1.000	9.000
Haya - Beech - Hêtre	*	1.000	9.000
Arce - Maple - Érable	*	1.000	9.000
Roble cocina - Special Oak colour - Special Rouvre	*	1.000	9.000

Colores disponibles Colours / Couleurs



CF - CAP

Tapon nylon de colores para tornillo de cabeza hexagonal

Nylon cap for hexagonal head screws in colours
Bouchon nylon pour vis tête hexagonale, différentes couleurs



Colores disponibles
Colours / Couleurs

Medida Size Dimension	Precio Price Prix	Envasado Packing Emboitage	Embalaje Carton Emballage
mm.	€/1.000	Und.	Und.
c/ 8 mm.	*	200	1.200
c/ 10 mm.	*	200	1.200

LOTU[®]

The fixing brand





Puntas

Bits
Embouts

PUNTAS PLANAS 1/4"X25



				Embalaje Carton / Emballage	Precio Price / Prix
		mm.	pulg.	Und.	€/Und.
800/1TZ	0,50 x 4,0	25	1"	10	*
800/1TZ	0,60 x 4,5	25	1"	10	*
800/1TZ	0,8 x 5,5	25	1"	10	*
800/1TZ	1,0 x 5,5	25	1"	10	*
800/1TZ	1,2 x 6,5	25	1"	10	*
800/1TZ	1,6 x 8,0	25	1"	10	*

PUNTAS PHILIPS 1/4"X25



				Embalaje Carton / Emballage	Precio Price / Prix
		mm.	pulg.	Und.	€/Und.
851/1TZ	PH1	25	1"	10	*
851/1TZ	PH2	25	1"	10	*
851/1TZ	PH3	25	1"	10	*

PUNTAS PHILIPS 1/4"X50



				Embalaje Carton / Emballage	Precio Price / Prix
		mm.	pulg.	Und.	€/Und.
851/4 TZ	PH1	50	2"	10	*
851/4 TZ	PH2	50	2"	10	*
851/4 TZ	PH3	50	2"	10	*

PUNTAS PHILIPS 1/4"X25 EXTRA DURAS



				Embalaje Carton / Emballage	Precio Price / Prix
		mm.	pulg.	Und.	€/Und.
851/1TH	PH1	25	1"	10	*
851/1TH	PH2	25	1"	10	*
851/1TH	PH3	25	1"	10	*

PUNTAS PHILIPS 1/4"X50 EXTRA DURAS



				Embalaje Carton / Emballage	Precio Price / Prix
		mm.	pulg.	Und.	€/Und.
851/4 TH	PH1	50	2"	10	*
851/4 TH	PH2	50	2"	10	*
851/4 TH	PH3	50	2"	10	*



PUNTAS POZIDRIV 1/4"X25 EXTRA DURAS

				Embalaje Carton / Emballage	Precio Price / Prix
		mm.	pulg.	Und.	€/Und.
855/1 TH	PZ-1	25	1"	10	*
855/1 TH	PZ-2	25	1"	10	*
855/1 TH	PZ-3	25	1"	10	*



PUNTAS POZIDRIV 1/4"X50 EXTRA DURAS

				Embalaje Carton / Emballage	Precio Price / Prix
		mm.	pulg.	Und.	€/Und.
855/4 TH	PZ-1	50	2"	10	*
855/4 TH	PZ-2	50	2"	10	*
855/4 TH	PZ-3	50	2"	10	*



PUNTAS TORX 1/4"X25 EXTRA DURAS

				Embalaje Carton / Emballage	Precio Price / Prix
		mm.	pulg.	Und.	€/Und.
867/1 TZ	TX-5	25	1"	10	*
867/1 TZ	TX-6	25	1"	10	*
867/1 TZ	TX-7	25	1"	10	*
867/1 TZ	TX-8	25	1"	10	*
867/1 TZ	TX-9	25	1"	10	*
867/1 TZ	TX-10	25	1"	10	*
867/1 TZ	TX-15	25	1"	10	*
867/1 TZ	TX-20	25	1"	10	*
867/1 TZ	TX-25	25	1"	10	*
867/1 TZ	TX-27	25	1"	10	*
867/1 TZ	TX-30	25	1"	10	*
867/1 TZ	TX-40	25	1"	10	*



PUNTAS TORX 1/4"X50 EXTRA DURAS

				Embalaje Carton / Emballage	Precio Price / Prix
		mm.	pulg.	Und.	€/Und.
867/4 Z	TX-8	50	2"	10	*
867/4 Z	TX-10	50	2"	10	*
867/4 Z	TX-15	50	2"	10	*
867/4 Z	TX-20	50	2"	10	*
867/4 Z	TX-25	50	2"	10	*
867/4 Z	TX-27	50	2"	10	*
867/4 Z	TX-30	50	2"	10	*
867/4 Z	TX-40	50	2"	10	*





PUNTAS ALLEN 1/4"X25

				Embalaje Carton / Emballage	Precio Price / Prix
		mm.	pulg.	Und.	€/Und.
840/1Z	SW-2,0	25	1"	10	*
840/1Z	SW-2,5	25	1"	10	*
840/1Z	SW-3,0	25	1"	10	*
840/1Z	SW-4,0	25	1"	10	*
840/1Z	SW-5,0	25	1"	10	*



APRIETA TUERCAS 1/4" MAGNÉTICOS

				Embalaje Carton / Emballage	Precio Price / Prix
		mm.	pulg.	Und.	€/Und.
869/4 M	SW-5,5	65	2 1/2"	5	*
869/5 M	SW-7	65	2 1/2"	5	*
869/6 M	SW-8	65	2 1/2"	5	*
869/7 M	SW-10	65	2 1/2"	5	*



ADAPTADOR MAGNÉTICO 1/4" PARA PUNTAS 1/4"

				Embalaje Carton / Emballage	Precio Price / Prix
		mm.	pulg.	Und.	€/Und.
893/4/1 K	D-6,3	50	2"	5	*



ADAPTADOR MAGNÉTICO + ANILLO DE RETENCIÓN DE 1/4 PARA PUNTAS 1/4"

				Embalaje Carton / Emballage	Precio Price / Prix
		mm.	pulg.	Und.	€/Und.
899/4/1 K	D-6,3	50	2"	5	*
899/4/1	D-6,3	75	3"	5	*





ADAPTADOR MAGNÉTICO DE CAMBIO RÁPIDO DE 1/4 PARA PUNTAS 1/4"

				Embalaje Carton / Emballage	Precio Price / Prix
		mm.	pulg.	Und.	€/Und.
895/4/1 K	D-6,3	52	2"	5	*



DESTORNILLADOR PORTA PUNTAS DE 1/4" CON DEPÓSITO

			Embalaje Carton / Emballage	Precio Price / Prix	
	mm.	pulg.	Und.	€/Und.	
819/1/6	D-6,3	10,5	4 3/4"	1	*



RAPIDAPTOR® UNIVERSAL C+E 1/4"

			Embalaje Carton / Emballage	Precio Price / Prix	
	mm.	pulg.	Und.	€/Und.	
888/4/1/ K	D-6,3	50	2"	5	*



DESTORNILLADOR PORTA PUNTAS KRAFTFORM KOMPAKT® 20 CON BOLSA

		Embalaje Carton / Emballage	Precio Price / Prix
	Incluye	Und.	€/Und.
KK 20	889/4 R	1 x 1/4" x 100	5
	800/1Z	1 x 1,0 x 5,5 x 25 1 x 1,2 x 6,5 x 25	
	851/1Z PH	1 x PH 1 x 25 1 x PH 2 x 25	
	855/1Z PZ	1 x PZ 1 x 25 1 x PZ 2 x 25	





LOTU[®]

The fixing brand



Otros elementos de fijación

Other fastenings

Autres éléments de fixation



ALCAYATAS ACERO CINCADO

Zinc-Plated Steel L-style concrete nails

Gonds à clouer en acier zingué

Medida Size Dimension	Precio Price Pri x	Envasado Packing Emboîtage	Embalaje Carton Emballage
mm.	€/3 kg	Und.	Und.
2,25 x 20	*	1	1
2,25 x 30	*	1	1
2,90 x 40	*	1	1



ESCARPIAS ACERO CINCADO

Zinc-Plated steel unshouldered hook

Gonds à visser en acier zingué

Medida Size Dimension	Precio Price Pri x	Envasado Packing Emboîtage	Embalaje Carton Emballage
mm.	€/3 kg	Und.	Und.
2,5 x 25	*	1	1
3 x 30	*	1	1
3,5 x 40	*	1	1
4 x 50	*	1	1
5 x 50	*	1	1
5 x 60	*	1	1
5 x 70	*	1	1
6 x 80	*	1	1
6 x 100	*	1	1



HEMBRILLAS ABIERTAS ACERO CINCADO

Zinc-Plated steel unshouldered cup hooks

Crochets à visser en acier zingué

Medida Size Dimension	Precio Price Pri x	Envasado Packing Emboîtage	Embalaje Carton Emballage
mm.	€/3 kg	Und.	Und.
2,5 x 10	*	1	1
3 x 16	*	1	1
3,5 x 20	*	1	1
3,5 x 25	*	1	1
4 x 30	*	1	1
5 x 40	*	1	1
6 x 50	*	1	1

HEMBRILLAS CERRADAS ACERO CINCADO

Zinc-Plated steel screw eyes
Pitons à visser en acier zingué



Medida Size Dimension	Precio Price Pri x	Envasado Packing Emboîtage	Embalaje Carton Emballage
mm.	€/3 kg	Und.	Und.
2,5 x 10	*	1	1
3 x 16	*	1	1
3,5 x 20	*	1	1
3,5 x 25	*	1	1
4 x 30	*	1	1
5 x 40	*	1	1
6 x 50	*	1	1

PUNTAS CABEZA PERDIDA LATONADO

Brass-Plated Steel headless nails
Embouts sans tête laitoné



Medida Size Dimension	Precio Price Pri x	Envasado Packing Emboîtage	Embalaje Carton Emballage
mm.	€/Bolsa 50g	Und.	Und.
2 x 30	*	1	60
2 x 40	*	1	60

PUNTAS CABEZA PERDIDA COBREDO

Copper-Plated headless nails
Embouts sans tête cuivrée



Medida Size Dimension	Precio Price Pri x	Envasado Packing Emboîtage	Embalaje Carton Emballage
mm.	€/Bolsa 50g	Und.	Und.
2 x 30	*	1	60
2 x 40	*	1	60

PUNTAS CABEZA PERDIDA ACERO PULIDO

Polished Steel headless nails
Embouts sans tête en acier zingué



Medida Size Dimension	Precio Price Pri x	Envasado Packing Emboîtage	Embalaje Carton Emballage
mm.	€/Bolsa 150g	Und.	Und.
1,01 x 15	*	1	20
1,3 x 20	*	1	20
1,5 x 25	*	1	20
1,5 x 30	*	1	20



PUNTAS CABEZA PERDIDA ACERO PULIDO

Polished Steel headless nails
Embouts sans tête en acier zingué

Medida Size Dimension	Precio Price Pri x	Envasado Packing Emboitage	Embalaje Carton Emballage
mm.	€/3 kg	Und.	Und.
2,2 x 40	*	1	1
2,2 x 50	*	1	1
2,7 x 60	*	1	1
2,7 x 70	*	1	1



PUNTAS CABEZA PLANA ACERO PULIDO

Polished Steel flat head nails
Embouts de tête fraisée en acier poli

Medida Size Dimension	Precio Price Pri x	Envasado Packing Emboitage	Embalaje Carton Emballage
mm.	€/Bolsa 150g	Und.	Und.
1,4 x 20	*	1	20
1,5 x 25	*	1	20
1,8 x 30	*	1	20



PUNTAS CABEZA PLANA ACERO PULIDO

Polished Steel flat head nails
Embouts de tête fraisée en acier poli

Medida Size Dimension	Precio Price Pri x	Envasado Packing Emboitage	Embalaje Carton Emballage
mm.	€/3 kg	Und.	Und.
2 x 35	*	1	1
2,2 x 40	*	1	1
2,4 x 50	*	1	1
3 x 60	*	1	1
3,4 x 70	*	1	1
3,4 x 80	*	1	1
3,9 x 90	*	1	1
4,4 x 100	*	1	1
4,9 x 110	*	1	1
5,9 x 130	*	1	1
6,4 x 140	*	1	1

PUNTAS CABEZA REDONDA ACERO TEMPLADO

Hardened Steel round head nails
Embouts de tête ronde en acier trempé

Medida Size Dimension	Precio Price Pri x	Envasado Packing Emboitage	Embalaje Carton Emballage
mm.	€/Bolsa 60g	Und.	Und.
2 x 23	*	1	50
2 x 30	*	1	50
2,7 x 40	*	1	50



GRAMPILLONES ACERO PULIDO

Polished Steel U-type nails
Crampillons en acier poli

Medida Size Dimension	Precio Price Pri x	Envasado Packing Emboitage	Embalaje Carton Emballage
mm.	€/3 kg	Und.	Und.
1,6 x 18	*	1	1
3 x 25	*	1	1



TACHUELA TAPICERO CINCADA

Zinc-Plated shoe tacks
Clous de tapissier en acier poli

Medida Size Dimension	Precio Price Pri x	Envasado Packing Emboitage	Embalaje Carton Emballage
mm.	€/Bolsa 150g	Und.	Und.
9 mm	*	1	20
12 mm	*		



PUNTA CABEZA ANCHA

Roofing nails
Clous de toiture

Medida Size Dimension	Precio Price Pri x	Envasado Packing Emboitage	Embalaje Carton Emballage
mm.	€/3 kg	Und.	Und.
3 x 16	*	1	1
3 x 20	*	1	1



LOTU[®]

The fixing brand



Especificaciones técnicas

Technical specifications
Specifications techniques





7505-A (PZ)

Cabeza plana pozi rosca un hilo 40°

Pozi countersunk head chipboard screw
Vis a bois aglomerée filet tête fraisée pozi

Medida Size Dimension		d (mm.)		D (mm.)		K (mm.)		Entalla Recess Empreinte
mm.		MAX	MIN	MAX	MIN	MAX	MIN	
2,50	17	2,60	2,25	5,00	4,70	1,40	1,20	PZ-1
3,00	18	3,10	2,75	6,00	5,60	1,80	1,55	PZ-2
3,50	19	3,60	3,20	7,00	6,60	2,00	1,75	PZ-2
4,00	20	4,10	3,70	8,00	7,60	2,35	2,05	PZ-2
4,50	21	4,60	4,20	9,00	8,50	2,55	2,25	PZ-2
5,00	22	5,10	4,70	10,00	9,50	2,85	2,55	PZ-2
5,50	23	5,60	5,20	11,00	10,40	3,20	2,85	PZ-3
6,00	24	6,10	5,70	12,00	11,40	3,60	3,20	PZ-3



7505-A (TX)

Cabeza plana TORX® rosca un hilo 40°

TORX® countersunk head chipboard screw
Vis a bois aglomerée filet 40° tête fraisée TORX®

Medida Size Dimension		d (mm.)		D (mm.)		K (mm.)		Entalla Recess Empreinte
mm.		MAX	MIN	MAX	MIN	MAX	MIN	
3,50	19	3,60	3,20	7,00	6,60	2,00	1,75	TX-20
4,00	20	4,10	3,70	8,00	7,60	2,35	2,05	TX-20
4,50	21	4,60	4,20	9,00	8,50	2,55	2,25	TX-25
5,00	22	5,10	4,70	10,00	9,50	2,85	2,55	TX-25



7505-B

Cabeza alomada pozi rosca un hilo 40°

Pozi pan head chipboard screw
Vis a bois aglomerée 40° tête cylindrique bombée large pozi

Medida Size Dimension		d (mm.)		D (mm.)		K (mm.)		Entalla Recess Empreinte
mm.		MAX	MIN	MAX	MIN	MAX	MIN	
2,50	17	2,60	2,25	5,00	4,70	2,10	1,20	PZ-1
3,00	18	3,10	2,75	5,60	5,30	2,20	1,95	PZ-1
3,50	19	3,60	3,20	6,50	6,20	2,60	2,35	PZ-2
4,00	20	4,10	3,70	7,50	7,14	2,80	2,55	PZ-2
4,50	21	4,60	4,20	8,20	7,84	3,05	2,75	PZ-2
5,00	22	5,10	4,70	9,50	9,14	3,55	3,25	PZ-2
5,50	23	5,60	5,20	10,80	10,37	3,95	3,65	PZ-3
6,00	24	6,10	5,70	12,00	11,50	4,35	4,00	PZ-3

TORNILLO ROSCA MADERA UN HILO 40°

Chipboard wood screw
Vis a bois aglomerée filet 40°

Longitud Length Longueur	L (mm.)	
	MAX	MIN
mm.		
10	10,75	9,25
12	12,90	11,10
13	13,90	12,10
15	15,90	14,10
16	16,90	15,10
17	17,90	16,10
20	21,05	18,95
25	26,05	23,95
30	31,05	28,95
35	36,25	33,75

Longitud Length Longueur	L (mm.)	
	MAX	MIN
mm.		
40	41,25	38,75
45	46,25	43,75
50	51,25	48,75
60	61,50	58,50
70	71,50	68,50
80	81,50	78,50
90	91,50	88,50
100	102,00	98,00
120	122,00	118,00
140	142,00	138,00

RAN-72

Cabeza plana ranura

Slotted countersunk head double thread wood screw
Vis a bois a deux filets tête fraisée fendue

Medida Size Dimension		d (mm.)		D (mm.)		K (mm.)		Entalla Recess Empreinte
mm.		MAX	MIN	MAX	MIN	MAX	MIN	
2,10	14	2,20	1,90	4,10	3,80	1,20	1,00	
2,40	16	2,50	2,15	4,90	4,55	1,40	1,20	
2,70	17	2,80	2,45	5,50	5,15	1,60	1,40	
3,00	18	3,10	2,75	6,00	5,60	1,80	1,55	
3,50	19	3,60	3,20	7,00	6,60	2,00	1,75	
4,00	20	4,10	3,70	8,00	7,60	2,35	2,05	
4,50	21	4,60	4,20	9,00	8,50	2,55	2,25	
5,00	22	5,10	4,70	10,00	9,50	2,85	2,55	
5,50	23	5,60	5,20	11,00	10,40	3,20	2,85	
6,00	24	6,10	5,70	12,00	11,40	3,60	3,20	



RED-74

Cabeza redonda ranura

Slotted rounded head double thread wood screw
Vis a bois a deux filets tête ronde fendue

Medida Size Dimension		d (mm.)		D (mm.)		K (mm.)		Entalla Recess Empreinte
mm.		MAX	MIN	MAX	MIN	MAX	MIN	
2,10	14	2,20	1,90	4,10	3,80	1,70	1,45	
2,40	16	2,50	2,15	4,90	4,55	1,80	1,55	
2,70	17	2,80	2,45	5,50	5,15	2,00	1,75	
3,00	18	3,10	2,75	6,00	5,60	2,40	2,10	
3,50	19	3,60	3,20	7,00	6,60	2,80	2,50	
4,00	20	4,10	3,70	8,00	7,60	3,00	2,70	
4,50	21	4,60	4,20	9,00	8,50	3,40	3,05	
5,00	22	5,10	4,70	10,00	9,50	4,00	3,65	
5,50	23	5,60	5,20	11,00	10,40	4,50	4,10	
6,00	24	6,10	5,70	12,00	11,40	5,00	4,60	





PHI - 82

Cabeza plana philips

Philips countersunk head double thread wood screw

Vis a bois a deux filets tête fraisée philips

Medida Size Dimension		d (mm.)		D (mm.)		K (mm.)		Entalla Recess Empreinte
mm.		MAX	MIN	MAX	MIN	MAX	MIN	
2,70	17	2,80	2,45	5,50	5,15	1,60	1,40	PH-1
3,00	18	3,10	2,75	6,00	5,60	1,80	1,55	PH-2
3,50	19	3,60	3,20	7,00	6,60	2,00	1,75	PH-2
4,00	20	4,10	3,70	8,00	7,60	2,35	2,05	PH-2
4,50	21	4,60	4,20	9,00	8,50	2,55	2,25	PH-2
5,00	22	5,10	4,70	10,00	9,50	2,85	2,55	PH-2
5,50	23	5,60	5,20	11,00	10,40	3,20	2,85	PH-3
6,00	24	6,10	5,70	12,00	11,40	3,60	3,20	PH-3

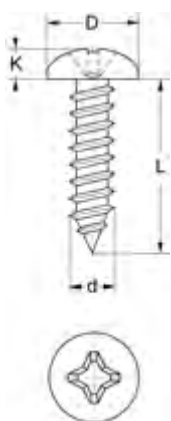

PHI - 81

Cabeza alomada philips rosca madera doble hilo

Philips pan head double thread wood screw

Vis a bois a deux filets tête cylindrique bombée large philipss

Medida Size Dimension		d (mm.)		D (mm.)		K (mm.)		Entalla Recess Empreinte
mm.		MAX	MIN	MAX	MIN	MAX	MIN	
2,70	17	2,80	2,45	5,20	4,90	2,10	1,85	PH-1
3,00	18	3,10	2,75	5,60	5,30	2,20	1,95	PH-1
3,50	19	3,60	3,20	6,90	6,54	2,60	2,35	PH-2
4,00	20	4,10	3,70	7,50	7,14	2,80	2,55	PH-2
4,50	21	4,60	4,20	8,20	7,84	3,05	2,75	PH-2
5,00	22	5,10	4,70	9,50	9,14	3,55	3,25	PH-2
5,50	23	5,60	5,20	10,80	10,37	3,95	3,65	PH-3
6,00	24	6,10	5,70	12,00	11,50	4,35	4,00	PH-3



GSB - 83

Cabeza gota sebo philips rosca madera doble hilo

Philips raised countersunk head double thread wood screw

Vis a bois a deux filets tête fraisée bombée philips

Medida Size Dimension		d (mm.)		D (mm.)		K (mm.)		Entalla Recess Empreinte
mm.		MAX	MIN	MAX	MIN	MAX	MIN	
2,70	17	2,80	2,45	5,50	5,15	1,60	1,40	PH-1
3,00	18	3,10	2,75	6,00	5,60	1,80	1,55	PH-1
3,50	19	3,60	3,20	7,00	6,60	2,00	1,75	PH-2
4,00	20	4,10	3,70	8,00	7,60	2,35	2,05	PH-2
4,50	21	4,60	4,20	9,00	8,50	2,55	2,25	PH-2
5,00	22	5,10	4,70	10,00	9,50	2,85	2,55	PH-2
5,50	23	5,60	5,20	11,00	10,40	3,20	2,85	PH-3
6,00	24	6,10	5,70	12,00	11,40	3,60	3,20	PH-3

TORNILLO ROSCA MADERA DOBLE HILO

Double thread wood screw

Vis a bois a deux filets

Longitud Length Longueur	L (mm.)	
	MAX	MIN
mm.		
10	10,75	9,25
12	12,90	11,10
13	13,90	12,10
15	15,90	14,10
16	16,90	15,10
17	17,90	16,10
20	21,05	18,95
25	26,05	23,95

Longitud Length Longueur	L (mm.)	
	MAX	MIN
mm.		
30	31,05	28,95
35	36,25	33,75
40	41,25	38,75
45	46,25	43,75
50	51,25	48,75
60	61,50	58,50
70	71,50	68,50
80	81,50	78,50

DIN 84 - 4.8

Cabeza cilíndrica ranura

Slotted cheese head machine screw

Vis a métaux tête cylindrique fendue

Medida Size Dimension	d (mm.)		D (mm.)		K (mm.)		Entalla Recess Empreinte
	MAX	MIN	MAX	MIN	MAX	MIN	
mm.							
M-2,5	2,48	2,38	4,50	4,32	1,60	1,46	
M-3	2,98	2,87	5,50	5,32	2,00	1,86	
M-3,5	3,48	3,35	6,00	5,82	2,40	2,26	
M-4	3,98	3,83	7,00	6,78	2,60	2,46	
M-5	4,98	4,82	8,50	8,28	3,30	3,12	
M-6	5,98	5,79	10,00	9,78	3,90	3,60	



DIN 963 - 4.8

Cabeza plana ranura recubrimiento

Slotted countersunk head machine screw

Vis a métaux tête fraisée fendue

Medida Size Dimension	d (mm.)		D (mm.)		K (mm.)		Entalla Recess Empreinte
	MAX	MIN	MAX	MIN	MAX	MIN	
mm.							
M-2,5	2,48	2,38	4,70	4,40	1,50	1,30	
M-3	2,98	2,87	5,60	5,30	1,65	1,45	
M-3,5	3,48	3,35	6,50	6,14	1,95	1,70	
M-4	3,98	3,83	7,50	7,14	2,20	1,90	
M-5	4,98	4,82	9,20	8,84	2,50	2,20	
M-6	5,98	5,79	11,00	10,57	3,00	2,70	



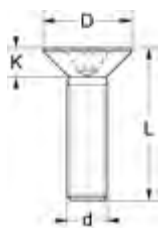

DIN 965 - 4.8

Cabeza plana philips

Philips countersunk head machine screw

Vis a metaux tête fraisée philips

Medida Size Dimension	d (mm.)		D (mm.)		K (mm.)		Entalla Recess Empreinte
	MAX	MIN	MAX	MIN	MAX	MIN	
mm.							
M-2,5	2,48	2,38	4,70	4,40	1,50	1,30	PH-1
M-3	2,98	2,87	5,60	5,30	1,65	1,45	PH-1
M-3,5	3,48	3,35	6,50	6,14	1,95	1,70	PH-2
M-4	3,98	3,83	7,50	7,14	2,20	1,90	PH-2
M-5	4,98	4,82	9,20	8,84	2,50	2,20	PH-2
M-6	5,98	5,79	11,00	10,57	3,00	2,70	PH-3

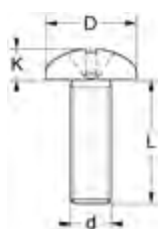

DIN 7985 - 4.8

Cabeza alomada philips

Philips pan head machine screw

Vis a metaux tête cylindrique bombée large philips

Medida Size Dimension	d (mm.)		D (mm.)		K (mm.)		Entalla Recess Empreinte
	MAX	MIN	MAX	MIN	MAX	MIN	
mm.							
M-2,5	2,48	2,38	5,00	4,70	2,12	1,88	PH-1
M-3	2,98	2,87	6,00	5,70	2,52	2,28	PH-1
M-3,5	3,48	3,35	7,00	6,64	2,82	2,58	PH-2
M-4	3,98	3,83	8,00	7,64	3,25	2,95	PH-2
M-5	4,98	4,82	10,00	9,64	3,95	3,65	PH-2
M-6	5,98	5,79	12,00	11,57	4,75	4,45	PH-3

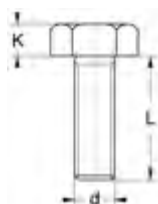

DIN 933

Cabeza hexagonal

Hexagonal head machine screw

Vis a metaux tête hexagonale

Medida Size Dimension	d (mm.)		D (mm.)		K (mm.)		Entalla Recess Empreinte
	MAX	MIN	MAX	MIN	MAX	MIN	
mm.							
M-2,5	2,48	2,38	5,00	4,82	1,82	1,58	
M-3	2,98	2,87	5,50	5,32	2,12	1,88	
M-3,5	3,48	3,35	6,00	5,82	2,52	2,28	
M-4	3,98	3,83	7,00	6,78	2,92	2,68	
M-5	4,98	4,82	8,00	7,78	3,65	3,35	
M-6	5,98	5,79	10,00	9,78	4,15	3,85	

DIN 912

Cabeza cilíndrica allen acero 8.8

Cylindrical head socket screw class 8.8

Tête cylindrique six pans creux classe 8.8

Medida Size Dimension	d (mm.)		D (mm.)		K (mm.)		Entalla Recess Empreinte
	MAX	MIN	MAX	MIN	MAX	MIN	
mm.							
M-4	3,98	3,83	7,00	6,78	4,00	3,82	SW3
M-5	4,98	4,82	8,50	8,28	5,00	4,82	SW4
M-6	5,98	5,79	10,00	9,78	6,00	5,70	SW5
M-8	7,97	7,76	13,00	12,73	8,00	7,64	SW6

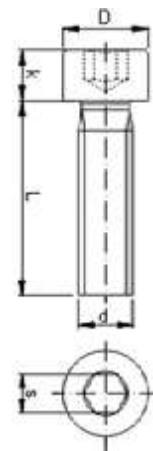

TORNILLO ROSCA MÉTRICA

Machine screw

Vis a métaux

Longitud Length Longueur	L (mm.)	
	MAX	MIN
mm.		
6	6,25	5,75
8	8,30	7,70
10	10,30	9,70
12	12,35	11,65
15	15,35	14,65
18	18,35	17,65
20	20,40	19,60
25	25,40	24,60
30	30,50	29,50
35	35,50	34,50
40	40,50	39,50
45	45,50	44,50
50	50,50	49,50
55	56,00	54,00
60	61,00	59,00
70	71,00	69,00
80	81,00	79,00

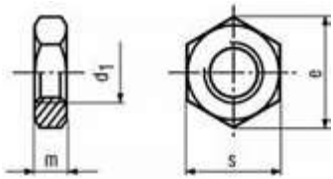

TUERCA DIN 934

Tuerca rosca métrica

Hexagonal nuts
Écrou hexagonale

Medida Size Dimension	s (mm.)	m (mm.)		e (mm.)
		MIN	MAX	
mm.				
M-3	5,5		2,40	2,15
M-4	7		3,20	2,90
M-5	8		4,00	3,70
M-6	10		5,00	4,70
M-8	13		6,50	6,14
M-10	17		8,00	7,64
M-12	19		10,00	9,64
M-14	22		11,00	10,30
M-16	24		13,00	12,30
M-18	27		15,00	14,30
M-20	30		16,00	14,90

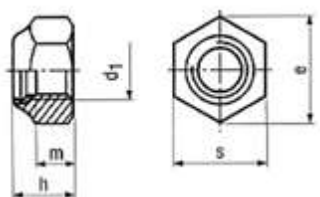

TUERCA DIN 985

Tuerca rosca métrica

Hexagonal nuts
Écrou hexagonale

Medida Size Dimension	s (mm.)	m (mm.)	h (mm.)		e (mm.)
			MAX	MIN	
mm.		MIN	MAX	MIN	MIN
M-4	7	2,90	5,00	4,70	7,66
M-6	10	4,00	6,00	5,70	11,05
M-8	13	5,50	8,00	7,64	14,38
M-10	17	6,50	10,00	9,64	18,90
M-20	30	30	16,00	14,90	32,95

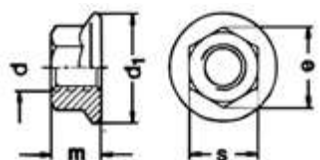

TUERCA DIN 963

Tuerca rosca métrica

Hexagonal nuts
Écrou hexagonale

Medida Size Dimension	s (mm.)	m (mm.)		d1 (mm.)	e (mm.)
		MAX	MIN		
mm.				MAX	MIN
M-6	10	6,00	5,70	14,20	11,05
M-8	13	8,00	7,60	17,90	14,38
M-10	15	10,00	9,60	21,80	16,64

TUERCA DIN 315 MARIPOSA

Wing nuts
Écrou a oreilles

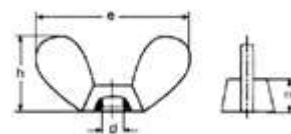

Medida Size Dimension	e (mm.)		h (mm.)		m (mm.)	
	MAX	MIN	MAX	MIN	MAX	MIN
mm.						
M-4	20,00	18,00	10,50	8,50	4,60	3,20
M-6	33,00	30,00	17,00	15,00	8,00	5,00
M-8	39,00	36,00	20,00	18,00	10,00	6,50
M-10	51,00	48,00	25,00	23,00	12,00	8,00

ARANDELA DIN 125 A

Washer
Rondelle

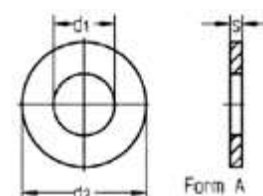

Medida Size Dimension	d1 (mm.)		d2 (mm.)		s (mm.)	
	MAX	MIN	MAX	MIN	MAX	MIN
mm.						
M-3	3,38	3,20	7,00	6,64	0,55	0,45
M-4	4,48	4,30	9,00	8,64	0,90	0,70
M-5	5,48	5,30	10,00	9,64	1,10	0,90
M-6	6,62	6,40	12,00	11,57	1,80	1,40
M-8	8,62	8,40	16,00	15,57	1,80	1,40
M-10	10,77	10,50	20,00	19,48	2,20	1,80
M-12	13,27	13,00	24,00	23,48	2,70	2,30
M-14	15,27	15,00	28,00	27,48	2,70	2,30
M-16	17,27	17,00	30,00	29,48	3,30	2,70
M-18	19,33	19,00	34,00	33,38	3,30	2,70
M-20	21,33	21,00	37,00	36,38	3,30	2,70

ARANDELA DIN 9021

Washer
Rondelle

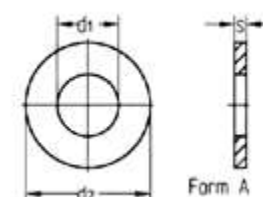

Medida Size Dimension	d1 (mm.)		d2 (mm.)		s (mm.)	
	MAX	MIN	MAX	MIN	MAX	MIN
mm.						
M-3	3,38	3,20	9,00	8,64	0,90	0,70
M-4	4,48	4,30	12,00	11,57	1,10	0,90
M-5	5,48	5,30	15,00	14,57	1,40	1,00
M-6	6,62	6,40	18,00	17,57	1,80	1,40
M-8	8,62	8,40	24,00	23,48	2,20	1,80
M-10	10,77	10,50	30,00	29,48	2,70	2,30
M-12	13,27	13,00	37,00	36,38	3,30	2,70
M-14	15,27	15,00	44,00	43,38	3,30	2,70
M-16	17,27	17,00	50,00	49,38	3,30	2,70
M-18	20,52	20,00	56,00	54,10	4,60	3,40
M-20	22,52	22,00	60,00	58,10	4,60	3,40

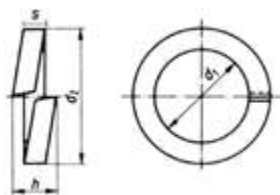

ARANDELA DIN 127 B

Washer
Rondelle

Medida Size Dimension	d1 (mm.)		d2 (mm.)	s (mm.)		h (mm.)	
	MAX	MIN	MAX	MAX	MIN	MAX	MIN
M-3	3,40	3,10	6,20	0,90	0,70	1,90	1,60
M-4	4,40	4,10	7,60	1,00	0,80	2,10	1,80
M-5	5,40	5,10	9,20	1,30	1,10	2,40	2,80
M-6	6,50	6,10	11,80	1,70	1,50	3,20	3,80
M-8	8,50	8,10	14,80	2,10	1,90	4,70	4,00
M-10	10,70	10,20	18,10	2,35	2,05	5,20	4,40

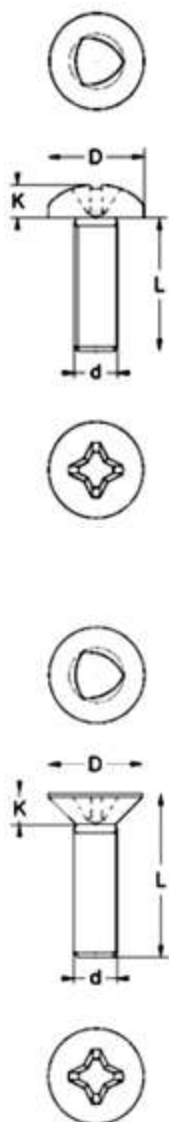

DIN 7500 C

Cabeza alomada philips rosca trilobular autorroscante

Philips pan head trilobular thread screw

Vis a métaux autotaraudeuse tête cylindrique bombée large philips

Medida Size Dimension	d (mm.)		D (mm.)		K (mm.)		Entalla Recess Empreinte
	MAX	MIN	MAX	MIN	MAX	MIN	
M-3	3,07	3,00	6,00	5,70	2,52	2,28	PH1
M-3,5	3,58	3,50	7,00	6,64	2,82	2,58	PH2
M-4	4,08	4,00	8,00	7,64	3,25	2,95	PH2
M-5	5,09	5,00	10,00	9,64	3,95	3,65	PH2
M-6	6,10	6,00	12,00	11,57	4,75	4,45	PH3

DIN 7500 M

Cabeza plana philips rosca trilobular autorroscante

Philips countersunk head trilobular thread screw

Vis a métaux autotaraudeuse tête fraisée philips

Medida Size Dimension	d (mm.)		D (mm.)		K (mm.)		Entalla Recess Empreinte
	MAX	MIN	MAX	MIN	MAX	MIN	
M-3	3,07	3,00	5,60	5,30	1,65	1,45	PH1
M-3,5	3,58	3,50	6,50	6,14	1,95	1,70	PH2
M-4	4,08	4,00	7,50	7,14	2,20	1,90	PH2
M-5	5,09	5,00	9,20	8,84	2,50	2,20	PH2
M-6	6,10	6,00	11,00	10,57	3,00	2,70	PH3

DIN 7981

Cabeza alomada philips

Philips pan head self tapping screw

Vis a tôle tête cylindrique bombée large philips

Medida Size Dimension		d (mm.)		D (mm.)		K (mm.)		Entalla Recess Empreinte
mm.		MAX	MIN	MAX	MIN	MAX	MIN	
2,20	2	2,24	2,10	4,20	3,90	1,80	1,55	PH-1
2,90	4	2,90	2,76	5,60	5,30	2,20	1,95	PH-1
3,20	5	3,30	3,12	6,20	5,86	2,40	2,15	PH-2
3,50	6	3,53	3,35	6,90	6,54	2,60	2,35	PH-2
3,90	7	3,91	3,73	7,50	7,14	2,80	2,55	PH-2
4,20	8	4,22	4,04	8,20	7,84	3,05	2,75	PH-2
4,80	10	4,80	4,62	9,50	9,14	3,55	3,25	PH-2
5,50	12	5,46	5,28	10,80	10,37	3,95	3,65	PH-3
6,30	14	6,25	6,03	12,50	12,07	4,55	4,25	PH-3



DIN 7981 F

Cabeza alomada philips punta F

Philips pan head self tapping screw point type F

Vis a tôle tête cylindrique bombée large philips bout plat

Medida Size Dimension		d (mm.)		D (mm.)		K (mm.)		Entalla Recess Empreinte
mm.		MAX	MIN	MAX	MIN	MAX	MIN	
2,20	2	2,24	2,10	4,20	3,90	1,80	1,55	PH-1
2,90	4	2,90	2,76	5,60	5,30	2,20	1,95	PH-1
3,20	5	3,30	3,12	6,20	5,86	2,40	2,15	PH-2
3,50	6	3,53	3,35	6,90	6,54	2,60	2,35	PH-2
3,90	7	3,91	3,73	7,50	7,14	2,80	2,55	PH-2
4,20	8	4,22	4,04	8,20	7,84	3,05	2,75	PH-2
4,80	10	4,80	4,62	9,50	9,14	3,55	3,25	PH-2
5,50	12	5,46	5,28	10,80	10,37	3,95	3,65	PH-3

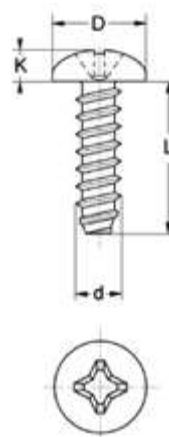

DIN 7981 G

Cabeza alomada philips punta guía

Philips pan head self tapping screw lead point

Vis a tôle tête cylindrique bombée large philips bout guide

Medida Size Dimension		d (mm.)		D (mm.)		K (mm.)		Entalla Recess Empreinte
mm.		MAX	MIN	MAX	MIN	MAX	MIN	
2,20	2	2,24	2,10	4,20	3,90	1,80	1,55	PH-1
2,90	4	2,90	2,76	5,60	5,30	2,20	1,95	PH-1
3,20	5	3,30	3,12	6,20	5,86	2,40	2,15	PH-2
3,50	6	3,53	3,35	6,90	6,54	2,60	2,35	PH-2
3,90	7	3,91	3,73	7,50	7,14	2,80	2,55	PH-2
4,20	8	4,22	4,04	8,20	7,84	3,05	2,75	PH-2
4,80	10	4,80	4,62	9,50	9,14	3,55	3,25	PH-2
5,50	12	5,46	5,28	10,80	10,37	3,95	3,65	PH-3

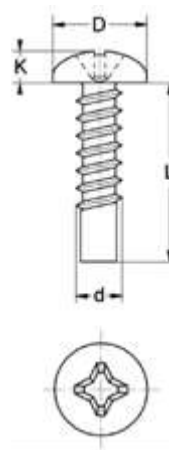



11C - 91

Cabeza alomada philips arandela estampada punta C

Philips pan head self tapping screw with washer

Vis a tôle tête cylindrique bombée large philips avec rondelle

Medida Size Dimension	d (mm.)		D (mm.)		K (mm.)		Entalla Recess Empreinte
	MAX	MIN	MAX	MIN	MAX	MIN	
mm.							
3,50	3,53	3,35	9,00	8,50	2,45	2,15	PH2
3,90	3,91	3,73	9,50	9,20	2,50	2,20	PH2
4,20	4,22	4,04	12,00	11,50	2,60	2,40	PH2
4,80	4,80	4,62	12,00	11,50	2,70	2,30	PH2

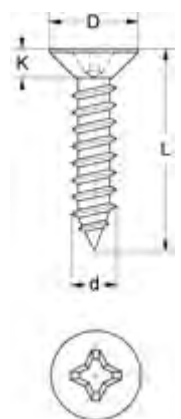

DIN 7982

Cabeza plana philips

Philips countersunk head self tapping screw

Vis a tôle tête fraisée philips

Medida Size Dimension	mm.	d (mm.)		D (mm.)		K (mm.)		Entalla Recess Empreinte
		MAX	MIN	MAX	MIN	MAX	MIN	
2,20	2	2,24	2,10	4,30	4,00	1,30	1,10	PH-1
2,90	4	2,90	2,76	5,50	5,20	1,70	1,45	PH-1
3,20	5	3,30	3,12	6,10	5,76	1,90	1,65	PH-2
3,50	6	3,53	3,35	6,80	6,44	2,10	1,85	PH-2
3,90	7	3,91	3,73	7,50	7,14	2,30	2,00	PH-2
4,20	8	4,22	4,04	8,10	7,74	2,50	2,15	PH-2
4,80	10	4,80	4,62	9,50	9,14	3,00	2,70	PH-2
5,50	12	5,46	5,28	10,80	10,37	3,40	3,05	PH-3
6,30	14	6,25	6,03	12,40	11,97	3,80	3,45	PH-3



DIN 7983

Cabeza gota sebo philips

Philips raised countersunk head self tapping screw

Vis a tôle tête fraisée bombée philips

Medida Size Dimension	mm.	d (mm.)		D (mm.)		K (mm.)		Entalla Recess Empreinte
		MAX	MIN	MAX	MIN	MAX	MIN	
2,20	2	2,24	2,10	4,30	4,00	1,30	1,10	PH-1
2,90	4	2,90	2,76	5,50	5,20	1,70	1,45	PH-1
3,20	5	3,30	3,12	6,10	5,76	1,90	1,65	PH-2
3,50	6	3,53	3,35	6,80	6,44	2,10	1,85	PH-2
3,90	7	3,91	3,73	7,50	7,14	2,30	2,00	PH-2
4,20	8	4,22	4,04	8,10	7,74	2,50	2,15	PH-2
4,80	10	4,80	4,62	9,50	9,14	3,00	2,70	PH-2
5,50	12	5,46	5,28	10,80	10,37	3,40	3,05	PH-3
6,30	14	6,25	6,03	12,40	11,97	3,80	3,45	PH-3

DIN 7971

Ancha ranura

Slotted pan head self tapping screw

Vis a tôle tête cylindrique fendue

Medida Size Dimension		d (mm.)		D (mm.)		K (mm.)		Entalla Recess Empreinte
mm.		MAX	MIN	MAX	MIN	MAX	MIN	
2,20	2	2,24	2,10	4,20	3,90	1,35	1,15	
2,90	4	2,90	2,76	5,60	5,30	1,75	1,50	
3,20	5	3,30	3,12	6,20	5,86	2,00	1,75	
3,50	6	3,53	3,35	6,90	6,54	2,10	1,85	
3,90	7	3,91	3,73	7,50	7,14	2,25	2,00	
4,20	8	4,22	4,04	8,20	7,84	2,45	2,15	
4,80	10	4,80	4,62	9,50	9,14	2,80	2,50	
5,50	12	5,46	5,28	10,80	10,37	3,20	2,85	
6,30	14	6,25	6,03	12,50	12,07	3,65	3,30	



DIN 6928

Cabeza hexagonal rosca chapa

Hexagonal head self tapping

Vis a tôle tête hexagonale

Medida Size Dimension	d (mm.)		D (mm.)		K (mm.)	
mm.	MAX	MIN	MAX	MIN	MAX	MIN
6,30	6,25	6,03	10,00	9,78	5,90	5,30

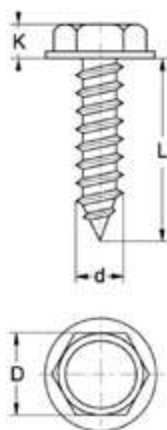

TORNILLO ROSCA CHAPA

Self tapping screw
Vis a tôles

Longitud Length Longueur		L (mm.)	
mm.		MAX	MIN
6,5	1/4"	7,30	5,70
9,5	3/8"	10,30	8,70
13	1/2"	13,80	12,20
16	5/8"	16,80	15,20
19	3/4"	19,80	18,20
22	7/8"	22,80	21,20
25	1"	25,80	24,20
32	1 1/4"	33,30	30,70
38	1 1/2"	39,30	36,70
45	1 3/4"	46,30	43,70

Longitud Length Longueur		L (mm.)	
mm.		MAX	MIN
50	2"	51,30	48,70
60	2 3/8"	61,60	58,40
70	2 3/4"	71,60	68,40
80		81,60	78,40
90		91,60	88,40
100		101,60	98,40
120		121,60	118,40

TORNILLO ROSCA CHAPA PAR MÁXIMO DE ATORNILLADO RECOMENDADO

Self tapping screw - Maximun recomend assembly torque
Vis a tôle - couple de vissage maximun

Longitud Length Longueur		Par máximo Couple Max. Maximun Torque
mm.		Kg/cm
2.20	2	2,50 kg/cm
2.90	4	8,30 kg/cm
3.20	5	11,20 kg/cm
3.50	6	15,00 kg/cm
3.90	7	18,50 kg/cm
4.20	8	24,50 kg/cm
4.80	10	35,00 kg/cm
5.50	12	52,00 kg/cm
6.30	14	77,00 kg/cm

* Si se realiza el montaje utilizando un par de atornillado superior al indicado en la tabla, habrá un elevado riesgo de rotura del tornillo.

* There will be a high risk of breaking if the assembly is done using a bigger couple than the indicated above.

* Si dans le montage on utilise un couple de vissage supérieur au signalé ci-dessus il y aura de risque de rupture.

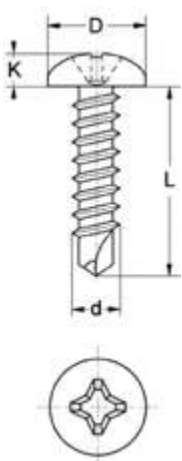

DIN 7504 N

Cabeza alomada philips rosca chapa autotaladrante

Philips pan head self drilling screw
Vis a tôle autoperceuse tête cylindrique bombée philips

Medida Size Dimension	d (mm.)		D (mm.)		K (mm.)		Entalla Recess Empreinte
	MAX	MIN	MAX	MIN	MAX	MIN	
3,50	3,53	3,35	6,90	6,54	2,60	2,35	PH2
3,90	3,91	3,73	7,50	7,14	2,80	2,55	PH2
4,20	4,22	4,04	8,20	7,84	3,05	2,75	PH2
4,80	4,80	4,62	9,50	9,14	3,55	3,25	PH2
5,50	5,46	5,28	10,80	10,37	3,95	3,65	PH3

16B - 91

Cabeza alomada philips arandela estampada autotaladrante

Philips pan head self tapping screw with washer

Vis a tôle tête cylindrique bombée large philips avec rondelle

Medida Size Dimension	d (mm.)		D (mm.)		K (mm.)		Entalla Recess Empreinte
	MAX	MIN	MAX	MIN	MAX	MIN	
mm.							
4,20	4,22	4,04	10,80	10,50	2,20	2,00	PH2
3,90	3,91	3,73	9,50	9,20	2,50	2,20	PH2
4,20	4,22	4,04	12,00	11,50	2,60	2,40	PH2
4,80	4,80	4,62	12,00	11,50	2,70	2,30	PH2

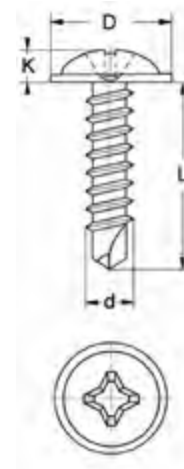

DIN 7504 P

Cabeza plana philips rosca chapa autotaladrante

Philips countersunk head self drilling screw

Vis a tôle autoperceuse tête fraisée philips

Medida Size Dimension	d (mm.)		D (mm.)		K (mm.)		Entalla Recess Empreinte
	MAX	MIN	MAX	MIN	MAX	MIN	
mm.							
3,50	3,53	3,35	6,80	6,44	2,60	2,35	PH2
3,90	3,91	3,73	7,50	7,14	2,80	2,55	PH2
4,20	4,22	4,04	8,10	7,74	3,05	2,75	PH2
4,80	4,80	4,62	9,50	9,14	3,55	3,25	PH2
5,50	5,46	5,28	10,80	10,37	3,95	3,65	PH3

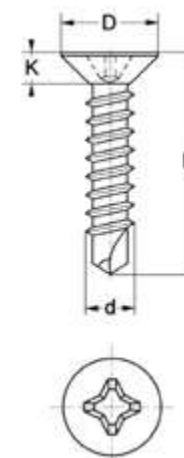

DIN 7504 K

Hexagonal rosca chapa autotaladrante

Hexagonal head self drilling screw

Vis à tôle autoperceuse tête hexagonale

Medida Size Dimension	d (mm.)		D (mm.)		K (mm.)	
	MAX	MIN	MAX	MIN	MAX	MIN
mm.						
3,50	3,53	3,35	5,50	5,32	3,45	3,20
3,90	3,91	3,73	5,50	5,32	3,45	3,20
4,20	4,22	4,04	7,00	6,78	4,25	4,00
4,80	4,80	4,62	8,00	7,78	4,45	4,15
5,50	5,46	5,28	8,00	7,78	5,45	5,15
6,30	6,25	6,03	10,00	9,78	6,45	6,15

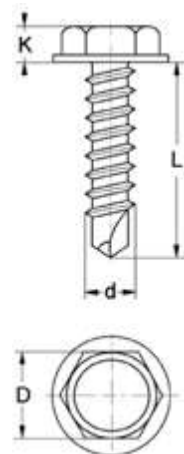

Diámetro de agujero recomendado para tornillos para chapa con rosca B (paso fino) según DIN 7970

Diameter of hole recommended for screws for metal sheets with B thread (fine pitch) in accordance with DIN 7970

Diamètre de trou recommandé pour les vis de tôle avec filet B (pas fin) selon DIN 7970

Número tornillo	Diámetro	Espesor de chapa		Mandrinado		Taladrado ó punzonado	
		Desde	Hasta	Chapa de acero, latón y NI-CU (Monel)	Chapa de aluminio (A1)	Chapa de acero, latón y NI-CU (Monel)	Chapa de aluminio (A1)
Núm. 2	Ø 2,2	-	0,50	-	-	1,6	-
		0,50	0,63	-	-	1,7	1,6
		0,63	0,75	-	-	1,8	1,6
		0,75	0,88	-	-	1,8	1,6
		0,88	1,00	-	-	1,8	1,6
		1,00	1,13	-	-	1,9	1,6
		1,13	1,25	-	-	1,9	1,7
		1,25	1,50	-	-	1,9	1,8
Núm. 4	Ø 2,9	-	0,50	2,2	-	2,2	-
		0,50	0,63	2,5	2,2	2,3	-
		0,63	0,75	2,5	2,2	2,4	2,2
		0,75	0,88	2,5	2,2	2,4	2,2
		0,88	1,00	2,5	2,2	2,4	2,2
		1,00	1,13	-	2,2	2,4	2,2
		1,13	1,25	-	-	2,5	2,2
		1,25	1,50	-	-	2,5	2,3
		1,50	2,00	-	-	2,6	2,3
2,00	2,50	-	-	-	2,4		
Núm. 6	Ø 3,5	-	0,50	2,8	-	2,6	-
		0,50	0,63	2,8	2,8	2,7	-
		0,63	0,75	2,8	2,8	2,7	2,6
		0,75	0,88	2,8	2,8	2,8	2,6
		0,88	1,00	2,8	2,8	2,8	2,6
		1,00	1,13	-	2,8	2,8	2,6
		1,13	1,25	-	2,8	2,8	2,6
		1,25	1,50	-	-	-	2,7
		1,50	2,00	-	-	-	2,8
		2,00	2,50	-	-	-	2,8
2,50	6,00	-	-	-	3,0		
Núm. 7	Ø 3,9	-	0,50	3,0	-	2,9	-
		0,50	0,63	3,0	3,0	2,9	-
		0,63	0,75	3,0	3,0	2,9	2,9
		0,75	0,88	3,0	3,0	2,9	2,9
		0,88	1,00	3,0	3,0	2,9	2,9
		1,00	1,13	3,0	3,0	2,9	2,9
		1,13	1,25	3,0	3,0	3,0	2,9
		1,25	1,50	-	-	3,3	3,0
		1,50	2,00	-	-	3,5	3,3
		2,00	2,50	-	-	3,6	3,5
2,50	6,00	-	-	-	3,5		

Diámetro de agujero recomendado para tornillos para chapa con rosca B (paso fino) según DIN 7970

Diameter of hole recommended for screws for metal sheets with B thread (fine pitch) in accordance with DIN 7970

Diamètre de trou recommandé pour les vis de tôle avec filet B (pas fin) selon DIN 7970

Número tornillo	Diámetro	Espesor de chapa		Mandrinado		Taladrado ó punzonado	
		Desde	Hasta	Chapa de acero, latón y NI-CU (Monel)	Chapa de aluminio (A1)	Chapa de acero, latón y NI-CU (Monel)	Chapa de aluminio (A1)
Núm, 8	Ø 4,2	-	0,50	3,5	-	2,9	-
		0,50	0,63	3,5	3,5	3,0	-
		0,63	0,88	3,5	3,5	3,0	2,90
		0,88	1,13	3,5	3,5	3,0	3,0
		1,13	1,25	3,5	3,5	3,3	3,3
		1,25	1,50	-	-	3,5	3,5
		1,50	2,00	-	-	3,6	3,6
		2,00	3,00	-	-	3,8	3,7
		3,00	3,50	-	-	3,9	3,8
		3,50	6,00	-	-	-	3,9
Núm, 10	Ø 4,8	-	0,50	4,0	-	-	-
		0,50	0,75	4,0	-	3,7	-
		0,75	0,88	4,0	-	3,8	-
		0,88	1,00	4,0	3,7	3,8	3,7
		1,00	1,25	4,0	3,7	3,9	3,7
		1,25	1,50	-	3,7	3,9	3,7
		1,50	2,00	-	3,7	4,0	3,7
		2,00	2,50	-	3,7	4,1	3,7
		2,50	3,50	-	3,9	4,3	3,9
		3,50	4,00	-	4,0	4,4	4,0
Núm, 12	Ø 5,5	-	1,00	4,7	-	4,2	-
		1,00	1,13	4,7	-	4,3	-
		1,13	1,25	4,7	4,1	4,3	4,1
		1,25	1,50	-	4,2	4,5	4,2
		1,50	2,00	-	4,4	4,6	4,4
		2,00	2,50	-	4,5	4,7	4,5
		2,50	3,00	-	4,6	4,9	4,6
		3,00	3,50	-	4,6	5,0	4,6
		3,50	4,00	-	4,8	5,0	4,8
		4,00	10,00	-	5,0	-	5,0
Núm, 14	Ø 6,3	-	0,88	5,3	-	4,7	-
		0,88	1,13	5,3	-	4,8	-
		1,13	1,25	5,3	-	4,9	-
		1,25	1,50	-	5,1	5,1	5,1
		1,50	2,00	-	5,1	5,3	5,1
		2,00	2,50	-	5,2	5,5	5,2
		2,50	3,00	-	5,3	5,7	5,3
		3,00	3,50	-	5,4	5,7	5,4
		3,50	4,00	-	5,4	5,9	5,4
		4,00	4,50	-	5,6	5,9	5,6
4,50	10,00	-	5,8	-	5,8		

Condiciones generales de venta

General sales conditions
Conditions de vente



1. Esta Tarifa de Precios sustituye y anula a todas las anteriores.
2. Los pedidos se considerarán en firme desde el momento de su recepción, implicando el hecho de pasar un pedido la aceptación por parte del Cliente de las condiciones de venta de INDUSTRIAS LOTU S.A.
3. El importe mínimo de pedido será de 60 euros (importe neto sin incluir IVA). En el caso de aceptarse un pedido de importe inferior se realizará un cargo en factura de 10 Euros.
4. La cantidad mínima por medida para fabricaciones especiales bajo encargo será de 100.000 unidades, según la medida del tornillo.
5. Los portes hasta destino serán pagados a partir de 300 Euros (importe neto sin incluir IVA).
6. La elección del medio de transporte será por cuenta de INDUSTRIAS LOTU S.A. En el caso de que el Cliente elija otro tipo de transporte, o un medio excepcionalmente urgente, los portes correrán a cargo del Cliente.
7. El Cliente deberá realizar la oportuna comprobación de conformidad, en relación al albarán de entrega, efectuando en caso contrario la reclamación al transportista antes de hacerse cargo de la mercancía.
8. En el caso de anomalías que originen posibles reclamaciones se informará de inmediato a INDUSTRIAS LOTU S.A., con el objeto de realizar las oportunas correcciones.
No se admitirán reclamaciones transcurrido un mes desde la fecha de entrega.
9. No se admitirá ninguna devolución de material sin la previa notificación por escrito y la aceptación de la misma por parte de INDUSTRIAS LOTU, S.A. En el abono de dicha devolución se realizará el cargo correspondiente a la puesta en almacén de dicha mercancía.

1. This Price List replaces and annuls all previous price lists.
2. Orders are considered as firm from the moment they are received. The placing of an order shall imply acceptance, on the part of the Client, of the conditions of sale of INDUSTRIAS LOTU S.A.
3. The minimum quantity for orders is 60 Euros (net amount, not including VAT). Should an order for less than this amount be accepted a surcharge of 10 Euros shall be added to the order.
4. The minimum quantity per measurement for special custom-made productions shall be 100.000 units, depending on the measurement of the screw.
5. Transport to the destination will be paid on quantities above 300 Euros (net amount, not including VAT).
6. The choice on mode of transport shall correspond to INDUSTRIAS LOTU S.A. Should the Client choose another type of transport, or an exceptionally urgent means of transport, the Client shall pay transport.
7. The Client should make the necessary check of approval in relation to the delivery note; otherwise the Client should present a claim to the forwarding agent prior to taking charge of the merchandise.
8. INDUSTRIAS LOTU S.A. should be informed immediately in the case of anomalies that lead to possible complaints in order to make the necessary rectifications.
Complaints made one month after the date of delivery shall not be accepted.
9. In any case, returns of material shall not be accepted without previous notification in writing and the acceptance of the same on the part of INDUSTRIAS LOTU, S.A. A charge corresponding to the cost of placing the material in the warehouse

1. Ce Tarif de Prix remplace et annule tous les précédents.
2. Les commandes seront considérées comme étant fermes dès l'instant de leur réception; la transmission d'une commande impliquera en conséquence l'acceptation, par le Client, des conditions de vente de INDUSTRIAS LOTU S.A.
3. Le montant minimum d'une commande sera de 60 Euros (montant net hors TVA). En cas d'acceptation d'une commande pour un montant inférieur, la facture présentera une surcharge de 10 Euros.
4. La quantité minimale par taille en cas de fabrications spéciales sur commande sera de 100.000 unités, en fonction des dimensions de la vis.
5. Les ports jusqu'au lieu de destination seront payés au-delà de 300 Euros de commande (montant net hors TVA).
6. Le choix du moyen de transport dépend de INDUSTRIAS LOTU S.A. Si le Client choisit un autre moyen de transport ou une messagerie express les coûts seront à la charge du Client.
7. Le Client devra effectuer la correspondante vérification de la conformité sur le bordereau de livraison et, en cas de désaccord, transmettra au transporteur sa réclamation avant d'accepter la marchandise.
8. Si des anomalies pouvant donner lieu à d'éventuelles réclamations sont repérées, INDUSTRIAS LOTU S.A. sera immédiatement informé de façon à pouvoir effectuer les corrections opportunes.
Aucune réclamation ne sera admise une fois écoulé un délai de un mois à compter de la date de livraison.
9. Aucun retour de marchandise ne sera admis sans notification préalable par écrit et acceptation de la part de INDUSTRIAS LOTU S.A. Du montant remboursé du matériel concerné sera déduit

LOTU 75 ANIVERSARIO

The fixing brand

Fabricación y distribución de tornillería y fijaciones metálicas

Desde hace más de 70 años proporcionando soluciones al sector de la fijación

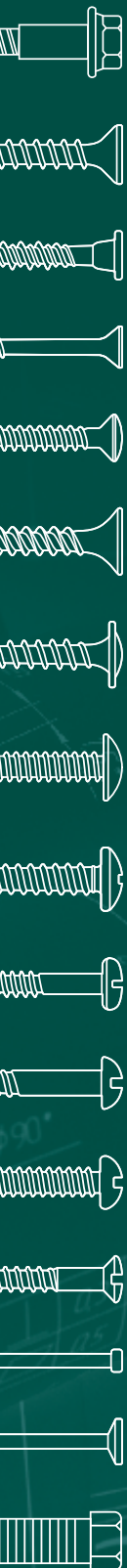

www.lotu.com